

Light-Duty (FHP) V-Belt Drives

B3

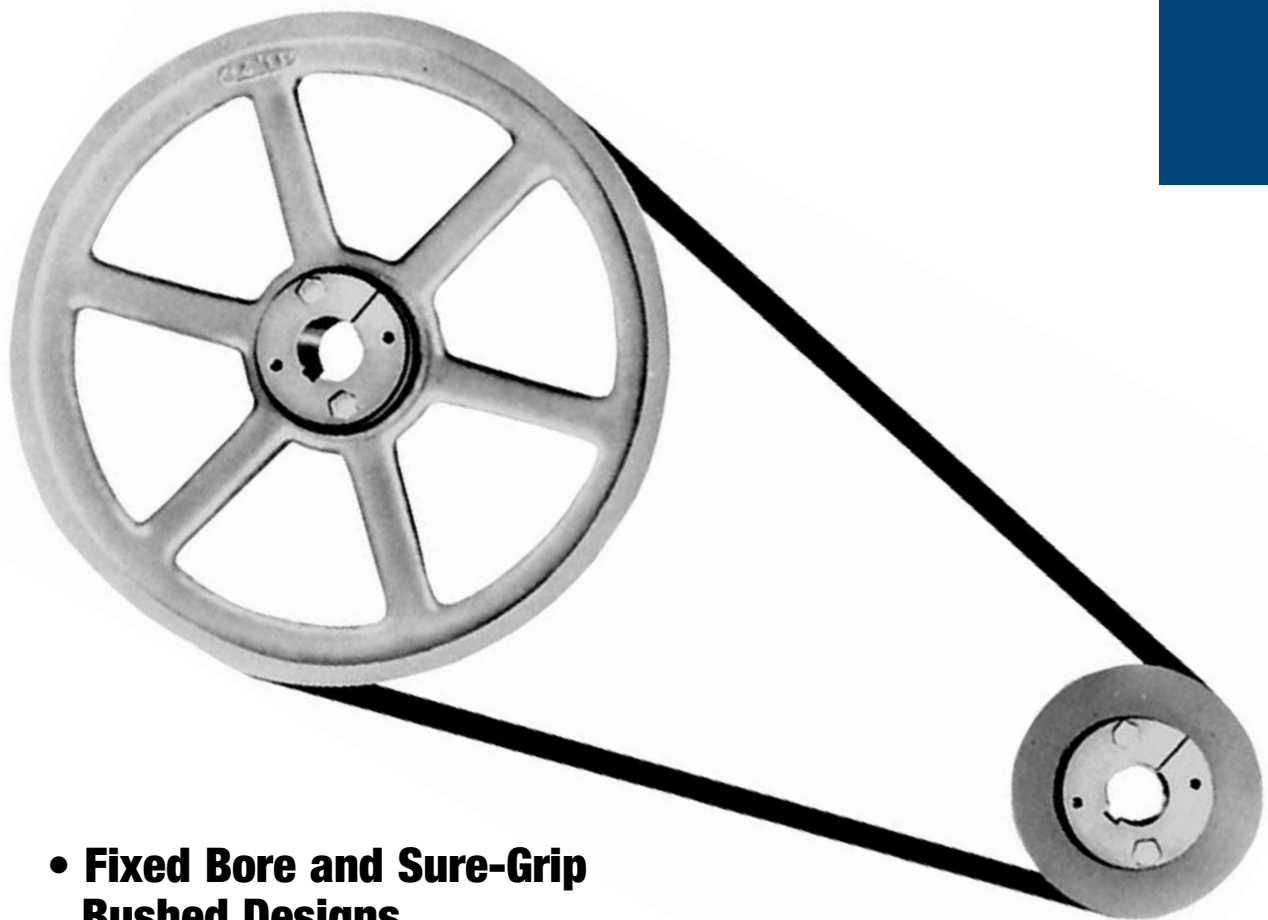

- **Fixed Bore and Sure-Grip Bushed Designs**
- **Cast Iron Sheaves**
- **Light-Duty V-Belts**

Light-Duty (FHP) Sheaves

Dimensions

- CAPACITIES TO 15 HP
- BORE SIZES FROM 1/2 TO 1-1/2 INCHES
- EASY-MOUNT SURE-GRIP QUICK-DETACHABLE BUSHINGS
- EFFICIENT, ECONOMICAL, LIGHTWEIGHT

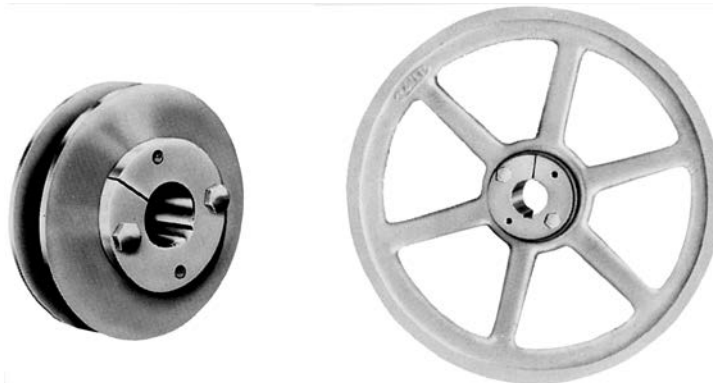

Light-duty sheaves are available in two types, both with one and two grooves. “A” sheaves are made to accommodate A (4L) belts; “B” sheaves are made for A (4L) or B (5L) belts. The two lines of sheaves have identical pitch diameters when using A or 4L belts.

Wood’s light-duty sheaves can be equipped with Wood’s “QT” Sure-Grip QD-type bushings. This quick-detachable tapered bushing is split through flange and tapered surface to provide a true clamp that is comparable to a shrink fit.

Sure-Grip bushings are easy to install and remove. The flange has two drilled and two tapped holes for easy assembly with two capscrews. Bore range is 1/2 through 1-1/2 in.

QT BUSHED SHEAVES FOR “A” BELTS

DATUM DIA.		O.D. ◆	Product No.	Single-Groove						Product No.	Two-Groove					
3L (O)	4L (A)			Type	DIMENSIONS				Wt. Lbs.		Type	DIMENSIONS				Wt. Lbs.
		E	F		L	M	E	F		L		M				
2.46	2.80	3.05	AK30	E1	3/8	3/4	1-1/4	7/8	1.7	2AK30	E1	1	1-3/8	1-1/4	7/8	2.0
2.66	3.00	3.25	AK32	E1	3/8	3/4	1-1/4	7/8	1.8	2AK32	E1	1	1-3/8	1-1/4	7/8	2.3
2.86	3.20	3.45	AK34	E1	1/16	3/4	1-1/4	9/16	1.8	2AK34	E1	9/16	1-3/8	1-1/4	7/16	2.4
3.16	3.50	3.75	AK39	E1	1/16	3/4	1-1/4	9/16	2.0	2AK39	E1	9/16	1-3/8	1-1/4	7/16	2.4
3.36	3.70	3.95	AK41	E1	1/16	3/4	1-1/4	9/16	2.2	2AK41	A2	1/16	1-3/8	1-1/4	1/16	2.5
3.66	4.00	4.25	AK44	E1	1/16	3/4	1-1/4	9/16	2.5	2AK44	A2	1/16	1-3/8	1-1/4	1/16	3.0
3.86	4.20	4.45	AK46	C2	1/16	3/4	1-1/4	9/16	2.5	2AK46	A2	1/16	1-3/8	1-1/4	1/16	3.1
4.16	4.50	4.75	AK49	C2	1/16	3/4	1-1/4	9/16	2.7	2AK49	A2	1/16	1-3/8	1-1/4	1/16	3.7
4.36	4.70	7.95	AK51	C2	1/16	3/4	1-1/4	9/16	2.9	2AK51	A2	1/16	1-3/8	1-1/4	1/16	3.8
4.66	5.00	5.25	AK54	C2	1/16	3/4	1-1/4	9/16	2.6	2AK54	A2	1/16	1-3/8	1-1/4	1/16	4.0
4.86	5.20	5.45	AK56	C2	1/16	3/4	1-1/4	9/16	2.9	2AK56	A2	1/16	1-3/8	1-1/4	1/16	4.2
5.16	5.50	5.75	AK59	C2	1/16	3/4	1-1/4	9/16	3.0	2AK59	D3	1/16	1-3/8	1-1/4	1/16	4.0
5.36	5.70	5.95	AK61	D3	1/16	3/4	1-1/4	9/16	3.1	2AK61	D3	1/16	1-3/8	1-1/4	1/16	3.9
5.66	6.00	6.25	AK64	D3	1/16	3/4	1-1/4	9/16	3.3	2AK64	D3	1/16	1-3/8	1-1/4	1/16	4.5
5.86	6.20	6.45	AK66	D3	1/16	3/4	1-1/4	9/16	3.4	-	-	-	-	-	-	-
6.16	6.50	6.75	AK69	D3	1/16	3/4	1-1/4	9/16	3.8	-	-	-	-	-	-	-
6.36	6.70	6.95	AK71	D3	1/16	3/4	1-1/4	9/16	3.7	-	-	-	-	-	-	-
6.66	7.00	7.25	AK74	D3	1/16	3/4	1-1/4	9/16	3.9	2AK74	D3	1/16	1-3/8	1-1/4	1/16	5.5
7.16	7.50	7.75	AK79	D3	1/16	3/4	1-1/4	9/16	4.1	-	-	-	-	-	-	-
7.66	8.00	8.25	AK84	D3	1/16	3/4	1-1/4	9/16	4.2	2AK84	D3	1/16	1-3/8	1-1/4	1/16	5.4
8.16	8.50	8.75	AK89	D3	1/16	3/4	1-1/4	9/16	4.6	-	-	-	-	-	-	-
8.66	9.00	9.25	AK94	D3	1/16	3/4	1-1/4	9/16	5.0	2AK94	D3	1/16	1-3/8	1-1/4	1/16	6.7
9.16	9.50	9.75	AK99	D3	1/16	3/4	1-1/4	9/16	5.3	-	-	-	-	-	-	-
9.66	10.00	10.25	AK104	D3	1/16	3/4	1-1/4	9/16	5.1	2AK104	D3	1/16	1-3/8	1-1/4	1/16	8.3
10.16	10.50	10.75	AK109	D3	1/16	3/4	1-1/4	9/16	5.7	-	-	-	-	-	-	-
10.66	11.00	11.25	AK114	D3	1/16	3/4	1-1/4	9/16	6.1	2AK114	D3	1/16	1-3/8	1-1/4	1/16	9.1
11.66	12.00	12.25	AK124	D3	1/16	3/4	1-1/4	9/16	6.7	2AK124	D3	1/16	1-3/8	1-1/4	1/16	10.1
12.66	13.00	13.25	AK134	D3	1/16	3/4	1-1/4	9/16	8.0	2AK134	D3	1/16	1-3/8	1-1/4	1/16	12.0
13.66	14.00	14.25	AK144	D3	1/16	3/4	1-1/4	9/16	8.4	2AK144	D3	1/16	1-3/8	1-1/4	1/16	12.5
14.66	15.00	15.25	AK154	D3	1/16	3/4	1-1/4	9/16	9.4	2AK154	D3	1/16	1-3/8	1-1/4	1/16	13.9
17.66	18.00	18.25	AK184	D3	1/16	3/4	1-1/4	9/16	11.9	2AK184	D3	1/16	1-3/8	1-1/4	1/16	17.4

Weights for all Sure-Grip bushed items are approximate and include bushing.

◆ P.D. for 4L same as O.D. P.D. for 3L = Datum Dia. + .25

Light-Duty (FHP) Sheaves

Dimensions

QT BUSHED SHEAVES FOR "B" BELTS

DATUM DIA.		O.D. ◆	Product No.	Single-Groove						Product No.	Two-Groove					
4L (A)	5L (B)			Type	DIMENSIONS				Wt. Lbs.		Type	DIMENSIONS				Wt. Lbs.
					E	F	L	M				E	F	L	M	
2.40	2.80	3.15	BK30	E1	1/2	7/8	1-1/4	7/8	1.8	-	-	-	-	-	-	-
2.60	3.00	3.35	BK32	E1	1/2	7/8	1-1/4	7/8	2.0	2BK32	E1	1-3/8	1-3/4	1-1/4	7/8	2.6
2.80	3.20	3.55	BK34	E1	1/2	7/8	1-1/4	7/8	2.2	2BK34	E1	1-3/8	1-3/4	1-1/4	7/8	3.0
3.00	3.40	3.75	BK36	C2	1/16	7/8	1-1/4	7/16	1.8	2BK36	E1	15/16	1-3/4	1-1/4	7/16	2.6
3.20	3.60	3.95	BK40	C2	1/16	7/8	1-1/4	7/16	2.0	2BK40	E1	15/16	1-3/4	1-1/4	7/16	3.0
3.50	3.90	4.25	BK45	C2	1/16	7/8	1-1/4	7/16	2.4	2BK45	E1	15/16	1-3/4	1-1/4	7/16	3.6
3.70	4.10	4.45	BK47	C2	1/16	7/8	1-1/4	7/16	2.8	2BK47	A2	1/16	1-3/4	1-1/4	7/16	3.4
4.00	4.40	4.75	BK50	C2	1/16	7/8	1-1/4	7/16	2.6	2BK50	A2	1/16	1-3/4	1-1/4	7/16	3.9
4.20	4.60	4.95	BK52	C2	1/16	7/8	1-1/4	7/16	2.7	2BK52	A2	1/16	1-3/4	1-1/4	7/16	4.2
4.50	4.90	5.25	BK55	C2	1/16	7/8	1-1/4	7/16	3.3	2BK55	A2	1/16	1-3/4	1-1/4	7/16	4.5
4.70	5.10	5.45	BK57	C2	1/16	7/8	1-1/4	7/16	3.3	2BK57	A2	1/16	1-3/4	1-1/4	7/16	4.9
5.00	5.40	5.75	BK60	C2	1/16	7/8	1-1/4	7/16	3.1	2BK60	A2	1/16	1-3/4	1-1/4	7/16	5.0
5.20	5.60	5.95	BK62	C2	1/16	7/8	1-1/4	7/16	3.2	2BK62	A2	1/16	1-3/4	1-1/4	7/16	5.1
5.50	5.90	6.25	BK65	C2	1/16	7/8	1-1/4	7/16	3.4	2BK65	D3	5/16	1-3/4	1-1/4	3/16	5.1
5.70	6.10	6.45	BK67	C2	1/16	7/8	1-1/4	7/16	3.5	2BK67	D3	5/16	1-3/4	1-1/4	3/16	5.6
6.00	6.40	6.75	BK70	D3	1/8	7/8	1-1/4	1/2	3.4	2BK70	D3	5/16	1-3/4	1-1/4	3/16	5.7
6.20	6.60	6.95	BK72	D3	1/8	7/8	1-1/4	1/2	3.7	2BK72	D3	5/16	1-3/4	1-1/4	3/16	6.0
6.50	6.90	7.25	BK75	D3	1/8	7/8	1-1/4	1/2	3.9	-	-	-	-	-	-	
6.70	7.10	7.45	BK77	D3	1/8	7/8	1-1/4	1/2	4.2	-	-	-	-	-	-	
7.00	7.40	7.75	BK80	D3	1/8	7/8	1-1/4	1/2	4.0	2BK80	D3	5/16	1-3/4	1-1/4	3/16	7.0
7.50	7.90	8.25	BK85	D3	1/8	7/8	1-1/4	1/2	4.2	-	-	-	-	-	-	
8.00	8.40	8.75	BK90	D3	1/8	7/8	1-1/4	1/2	4.9	2BK90	D3	5/16	1-3/4	1-1/4	3/16	8.2
8.50	8.90	9.25	BK95	D3	1/8	7/8	1-1/4	1/2	5.6	-	-	-	-	-	-	
9.00	9.40	9.75	BK100	D3	1/8	7/8	1-1/4	1/2	5.8	2BK100	D3	5/16	1-3/4	1-1/4	3/16	9.0
9.50	9.90	10.25	BK105	D3	1/8	7/8	1-1/4	1/2	6.1	-	-	-	-	-	-	
10.00	10.40	10.75	BK110	D3	1/8	7/8	1-1/4	1/2	6.6	2BK110	D3	5/16	1-3/4	1-1/4	3/16	9.9
10.50	10.90	11.25	BK115	D3	1/8	7/8	1-1/4	1/2	7.0	-	-	-	-	-	-	
11.00	11.40	11.75	BK120	D3	1/8	7/8	1-1/4	1/2	7.5	2BK120	D3	5/16	1-3/4	1-1/4	3/16	11.6
12.00	12.40	12.75	BK130	D3	1/8	7/8	1-1/4	1/2	7.5	2BK130	D3	5/16	1-3/4	1-1/4	3/16	13.7
13.00	13.40	13.75	BK140	D3	1/8	7/8	1-1/4	1/2	9.1	2BK140	D3	5/16	1-3/4	1-1/4	3/16	15.4
14.00	14.40	14.75	BK150	D3	1/8	7/8	1-1/4	1/2	10.1	-	-	-	-	-	-	
15.00	15.40	15.75	BK160	D3	1/8	7/8	1-1/4	1/2	10.4	2BK160	D3	5/16	1-3/4	1-1/4	3/16	18.1
18.00	18.40	18.75	BK190	D3	1/8	7/8	1-1/4	1/2	13.4	2BK190	D3	5/16	1-3/4	1-1/4	3/16	22.1

Weight for all Sure-Grip bushed items are approximate and include the bushing.

◆ P.D. for A Belts = Datum Dia. + .38

P.D. for B belts = Datum Dia. + .413

For Sure-Grip Bushing Stock Bores and Keyseat information, refer to A1 section.

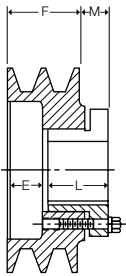

Type E1
(two-groove)

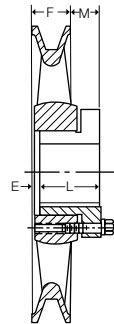

Type D3
(single-groove)

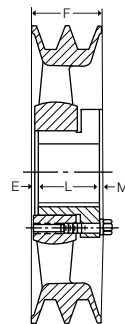

Type D3
(two-groove)

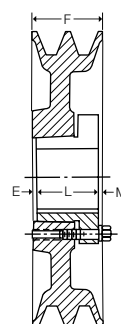

Type A2
(two-groove)

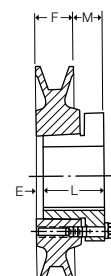

Type C2
(single-groove)

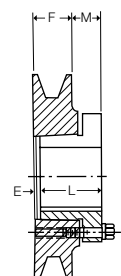

Type E1
(single-groove)

Single Groove (FHP) Bored-To-Size Sheaves

Dimensions

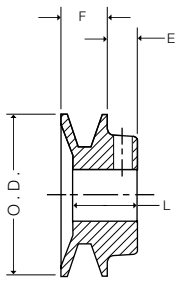

Type 1

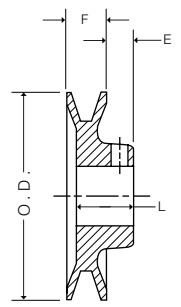

Type 2

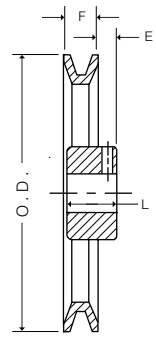

Type 3

BTS SHEAVES FOR "A" BELTS

Product No.	Datum Dia.		O.D. ◆	Stock Bores	Max. Bore	Type	No. of Arms	Dimensions			Wt. Lbs.
	3L (O)	4L (A)						"E" Dim.	"F" Dim.	"L" Dim.	
AK15	-	1.30	1.55	1/2 - 5/8	5/8	1	N/A	7/16	21/32	1-3/32	0.4
AK16	-	1.40	1.65	1/2 - 5/8	5/8	1	N/A	7/16	21/32	1-3/32	0.4
AK17	-	1.50	1.75	1/2 - 5/8 - 3/4	7/8	1	N/A	7/16	21/32	15/16	0.4
AK18	-	1.60	1.85	5/8	7/8	1	N/A	7/16	21/32	15/16	0.4
AK19	-	1.70	1.95	1/2 - 5/8 - 3/4 - 7/8	7/8	1	N/A	7/16	21/32	15/16	0.5
AK20	1.46	1.80	2.05	1/2 - 5/8 - 3/4	7/8	1	N/A	7/16	21/32	15/16	0.5
AK21	1.56	1.90	2.15	1/2 - 5/8 - 3/4	7/8	1	N/A	7/16	21/32	15/16	0.5
AK22	1.66	2.00	2.25	1/2 - 5/8 - 3/4 - 7/8	1"	1	N/A	7/16	21/32	15/16	0.6
AK23	1.76	2.10	2.35	1/2 - 5/8 - 3/4	1"	1	N/A	7/16	21/32	15/16	0.6
AK24	1.86	2.20	2.45	1/2 - 5/8 - 3/4 - 7/8 - 1	1"	1	N/A	7/16	21/32	15/16	0.6
AK25	1.96	2.30	2.55	1/2 - 5/8 - 3/4 - 7/8	1"	2	N/A	7/16	21/32	15/16	0.7
AK26	2.06	2.40	2.65	1/2 - 5/8 - 3/4	1"	2	N/A	7/16	21/32	15/16	0.8
AK27	2.16	2.50	2.75	1/2 - 5/8 - 3/4 - 1 - 7/8	1"	2	N/A	7/16	21/32	15/16	0.8
AK28	2.26	2.60	2.85	1/2 - 5/8 - 3/4 - 7/8	1"	2	N/A	7/16	21/32	15/16	0.9
AK30	2.46	2.80	3.05	1/2 - 5/8 - 3/4 - 7/8 - 1	1"	2	N/A	7/16	21/32	15/16	0.9
AK32	2.66	3.00	3.25	1/2 - 5/8 - 3/4 - 7/8 - 1 - 1-1/8	1-1/8	2	N/A	7/16	21/32	15/16	1
AK34	2.86	3.20	3.45	1/2 - 5/8 - 3/4 - 7/8 - 1 - 1-1/8	1-1/8	2	N/A	7/16	21/32	15/16	1.1
AK35	2.96	3.30	3.55	1/2 - 5/8 - 3/4 - 7/8 - 1	1"	2	N/A	7/16	21/32	15/16	1
AK39	3.16	3.50	3.75	1/2 - 5/8 - 3/4 - 7/8 - 15/16 - 1 - 1-1/8	1-1/8	2	N/A	15/32	3/4	1-5/32	1.6
AK41	3.36	3.70	3.95	1/2 - 5/8 - 3/4 - 7/8 - 15/16 - 1 - 1-1/8	1-1/8	2	N/A	15/32	3/4	1-5/32	1.7
AK44	3.66	4.00	4.25	1/2 - 5/8 - 3/4 - 7/8 - 15/16 - 1 - 1-1/8	1-1/8	3	3	15/32	3/4	1-5/32	1.9
AK46	3.86	4.20	4.45	1/2 - 5/8 - 3/4 - 7/8 - 15/16 - 1 - 1-1/8	1-1/8	3	3	15/32	3/4	1-5/32	1.8
AK49	4.16	4.50	4.75	1/2 - 5/8 - 3/4 - 7/8 - 15/16 - 1 - 1-1/8	1-1/8	3	3	15/32	3/4	1-5/32	1.9
AK51	4.36	4.70	4.95	1/2 - 5/8 - 3/4 - 7/8 - 1 - 1-1/8	1-5/16	3	3	15/32	3/4	1-5/32	2.2
AK54	4.66	5.00	5.25	1/2 - 5/8 - 3/4 - 7/8 - 15/16 - 1 - 1-1/8 - 1-3/16	1-5/16	3	3	15/32	3/4	1-5/32	2.2
AK56	4.86	5.20	5.45	1/2 - 5/8 - 3/4 - 7/8 - 15/16 - 1 - 1-1/8 - 1-3/16	1-5/16	3	3	15/32	3/4	1-5/32	2.3
AK59	5.16	5.50	5.75	1/2 - 5/8 - 3/4 - 7/8 - 15/16 - 1 - 1-1/8 - 1-3/16	1-3/8	3	3	15/32	3/4	1-5/32	2.5
AK61	5.36	5.70	5.95	1/2 - 5/8 - 3/4 - 7/8 - 15/16 - 1 - 1-1/8 - 1-3/16	1-3/8	3	3	15/32	3/4	1-5/32	2.4
AK64	5.66	6.00	6.25	1/2 - 5/8 - 3/4 - 7/8 - 15/16 - 1 - 1-1/8 - 1-3/16	1-3/8	3	3	15/32	3/4	1-5/32	2.8
AK66	5.86	6.20	6.45	5/8 - 3/4 - 1 - 1-1/8	1-3/8	3	3	15/32	3/4	1-5/32	2.8
AK69	6.16	6.50	6.75	3/4 - 1 - 1-1/8	1-9/16	3	6	23/32	3/4	1-15/32	3.7
AK71	6.36	6.70	6.95	1/2 - 5/8 - 3/4 - 1 - 1-1/8 - 1-7/16	1-11/16	3	6	23/32	3/4	1-15/32	3.9
AK74	6.66	7.00	7.25	1/2 - 5/8 - 3/4 - 15/16 - 1 - 1-1/8 - 1-3/16 - 1-1/4 - 1-7/16	1-11/16	3	6	23/32	3/4	1-15/32	4.1
AK79	7.16	7.50	7.75	3/4 - 1 - 1-1/8 - 1-7/16	1-11/16	3	6	23/32	3/4	1-15/32	4.6
AK81	7.36	7.70	7.95	5/8 - 3/4 - 1	1-11/16	3	6	23/32	3/4	1-15/32	4.5
AK84	7.66	8.00	8.25	1/2 - 5/8 - 3/4 - 15/16 - 1 - 1-3/16 - 1-7/16	1-11/16	3	6	23/32	3/4	1-15/32	4.7
AK89	8.16	8.50	8.75	3/4 - 1 - 1-1/8 - 1-7/16	1-11/16	3	6	23/32	3/4	1-15/32	4.9
AK91	8.36	8.70	8.95	3/4 - 1	1-11/16	3	6	23/32	3/4	1-15/32	5
AK94	8.66	9.00	9.25	1/2 - 5/8 - 3/4 - 15/16 - 1 - 1-3/16 - 1-1/4 - 1-7/16 - 7/8	1-11/16	3	6	23/32	3/4	1-15/32	5.3
AK99	9.16	9.50	9.75	3/4 - 1 - 1-7/16	1-11/16	3	6	23/32	3/4	1-15/32	5.5
AK104	9.66	10.00	10.25	5/8 - 3/4 - 1 - 1-3/16 - 1-1/4 - 1-3/8 - 1-7/16 - 7/8	1-11/16	3	6	23/32	3/4	1-15/32	5.7
AK109	10.16	10.50	10.75	3/4 - 1 - 1-3/8 - 1-7/16	1-11/16	3	6	23/32	3/4	1-15/32	6
AK114	10.66	11.00	11.25	3/4 - 1 - 1-3/16 - 1-7/16	1-11/16	3	6	23/32	3/4	1-15/32	6.3
AK124	11.66	12.00	12.25	5/8 - 3/4 - 1 - 1-3/16 - 1-1/4 - 1-7/16	1-11/16	3	6	23/32	3/4	1-15/32	7.1
AK134	12.66	13.00	13.25	3/4 - 1 - 1-3/16 - 1-3/8 - 1-7/16	1-11/16	3	6	23/32	3/4	1-15/32	7.7
AK144	13.66	14.00	14.25	3/4 - 1 - 1-3/16 - 1-7/16	1-11/16	3	6	23/32	3/4	1-15/32	8.6
AK154	14.66	15.00	15.25	3/4 - 1 - 1-3/16 - 1-7/16	1-11/16	3	6	23/32	3/4	1-15/32	9.6
AK184	17.66	18.00	18.25	3/4 - 1 - 1-3/16 - 1-7/16	1-11/16	3	6	23/32	3/4	1-15/32	12.7

P.D. for A same as O.D. P.D. for 3L = Datum Dia. + .25

Product Number Example: **AK8434** _____ BORE SIZE

Standard Keyseat Dimensions

Shaft Dia.	Width	Depth
1/2	No Keyseat	
5/8 - 7/8	3/16	3/32
15/16 - 1-1/4	1/4	1/8
1-5/16 - 1-3/8	5/16	5/32
1-7/16 - 1-3/4	3/8	3/16

Two Groove (FHP) Bored-To-Size Sheaves

Dimensions

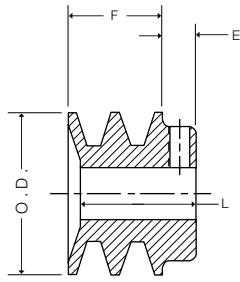

Type 1A

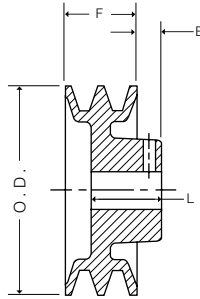

Type 2A

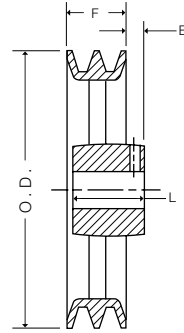

Type 3A

BTS SHEAVES FOR "A" BELTS

Product No.	Datum Dia.		O.D. ◆	Stock Bores	Max. Bore	Type	No. of Arms	Dimensions			Wt. Lbs.
	3L (O)	4L (A)						"E" Dim.	"F" Dim.	"L" Dim.	
2AK20	1.46	1.80	2.05	1/2 - 5/8 - 3/4 - 7/8*	15/16	1A	N/A	15/32	1-3/8	1-21/32	0.9
2AK21	1.56	1.90	2.15	1/2 - 5/8 - 3/4 - 7/8 - 1*	15/16	1A	N/A	15/32	1-3/8	1-21/32	1
2AK22	1.66	2.00	2.25	1/2 - 5/8 - 3/4 - 7/8 - 1*	1"	1A	N/A	15/32	1-3/8	1-21/32	1.1
2AK23	1.76	2.10	2.35	5/8 - 3/4 - 7/8 - 1	1-1/8	1A	N/A	15/32	1-3/8	1-21/32	1.3
2AK25	1.96	2.30	2.55	1/2 - 5/8 - 3/4 - 7/8 - 1 - 1-1/8	1-1/8	1A	N/A	15/32	1-3/8	1-21/32	1.5
2AK26	2.06	2.40	2.65	5/8 - 3/4 - 7/8	1-1/8	1A	N/A	15/32	1-3/8	1-21/32	1.6
2AK27	2.16	2.50	2.75	5/8 - 3/4 - 7/8 - 1 - 1-1/8	1-1/8	1A	N/A	15/32	1-3/8	1-21/32	1.7
2AK28	2.26	2.60	2.85	5/8 - 3/4 - 7/8 - 1	1-1/8	1A	N/A	15/32	1-3/8	1-21/32	1.8
2AK30	2.46	2.80	3.05	1/2 - 5/8 - 3/4 - 7/8 - 1 - 1-1/8	1-1/8	1A	N/A	15/32	1-3/8	1-21/32	2
2AK32	2.66	3.00	3.25	1/2 - 5/8 - 3/4 - 7/8 - 1 - 1-1/8	1-1/8	1A	N/A	15/32	1-3/8	1-21/32	2.3
2AK34	2.86	3.20	3.45	1/2 - 5/8 - 3/4 - 7/8 - 1 - 1-1/8	1-1/8	1A	N/A	15/32	1-3/8	1-21/32	2.6
2AK39	3.16	3.50	3.75	1/2 - 5/8 - 3/4 - 7/8 - 1 - 1-1/8	1-1/8	2A	N/A	15/32	1-3/8	1-11/32	2.6
2AK41	3.36	3.70	3.95	5/8 - 3/4 - 7/8 - 1 - 1-1/8	1-3/8	2A	N/A	15/32	1-3/8	1-11/32	2.8
2AK44	3.66	4.00	4.25	5/8 - 3/4 - 7/8 - 1 - 1-1/8	1-3/8	2A	N/A	15/32	1-3/8	1-11/32	3.2
2AK46	3.86	4.20	4.45	5/8 - 7/8 - 1 - 1-1/8	1-3/8	2A	N/A	15/32	1-3/8	1-11/32	3.2
2AK49	4.16	4.50	4.75	3/4 - 7/8 - 1 - 1-1/8 - 1-3/8	1-7/16	2A	N/A	15/32	1-3/8	1-11/32	3.6
2AK51	4.36	4.70	4.95	3/4 - 7/8 - 1 - 1-1/8 - 1-3/8	1-7/16	2A	N/A	15/32	1-3/8	1-11/32	3.3
2AK54	4.66	5.00	5.25	5/8 - 3/4 - 7/8 - 1 - 1-1/8 - 1-3/8	1-7/16	3A	3	15/32	1-3/8	1-11/32	3.8
2AK56	4.86	5.20	5.45	5/8 - 3/4 - 1 - 1-1/8 - 1-3/8	1-7/16	3A	3	15/32	1-3/8	1-11/32	4.1
2AK59	5.16	5.50	5.75	1 - 1-1/8 - 1-3/8	1-7/16	3A	3	15/32	1-3/8	1-11/32	3.9
2AK61	5.36	5.70	5.95	3/4 - 7/8 - 1 - 1-1/8 - 1-3/8	1-7/16	3A	3	15/32	1-3/8	1-11/32	4
2AK64	5.66	6.00	6.25	3/4 - 1 - 1-1/8 - 1-3/16 - 1-3/8 - 1-7/16	1-11/16	3A	3	11/32	1-3/8	1-19/32	4.9
2AK74	6.66	7.00	7.25	3/4 - 1 - 1-1/8 - 1-3/16 - 1-3/8 - 1-7/16	1-11/16	3A	6	11/32	1-3/8	1-19/32	6
2AK84	7.66	8.00	8.25	3/4 - 15/16 - 1 - 1-1/8 - 1-3/16 - 1-3/8 - 1-7/16	1-11/16	3A	6	11/32	1-3/8	1-19/32	6.6
2AK94	8.66	9.00	9.25	3/4 - 1 - 1-1/8 - 1-3/16 - 1-3/8 - 1-7/16	1-11/16	3A	6	11/32	1-3/8	1-19/32	7.5
2AK104	9.66	10.00	10.25	3/4 - 15/16 - 1 - 1-3/16 - 1-7/16	1-11/16	3A	6	11/32	1-3/8	1-19/32	8.5
2AK114	10.66	11.00	11.25	1 - 1-3/16 - 1-3/8 - 1-7/16	1-11/16	3A	6	11/32	1-3/8	1-19/32	9.3
2AK124	11.66	12.00	12.25	1 - 1-3/16 - 1-7/16	1-11/16	3A	6	11/32	1-3/8	1-19/32	10.1
2AK134	12.66	13.00	13.25	1-3/16 - 1-7/16	1-11/16	3A	6	11/32	1-3/8	1-19/32	10.9
2AK144	13.66	14.00	14.25	1 - 1-7/16	1-11/16	3A	6	11/32	1-3/8	1-19/32	12.2
2AK154	14.66	15.00	15.25	1-3/16 - 1-7/16	1-11/16	3A	6	11/32	1-3/8	1-19/32	13.8
2AK184	17.66	18.00	18.25	1-3/16 - 1-7/16	1-11/16	3A	6	11/32	1-3/8	1-19/32	17

*Cannot use 3L belt

Standard Keyseat Dimensions

Shaft Dia.	Width	Depth
1/2	No Keyseat	
5/8 - 7/8	3/16	3/32
15/16 - 1-1/4	1/4	1/8
1-5/16 - 1-3/8	5/16	5/32
1-7/16 - 1-3/4	3/8	3/16

P.D. for A same as O.D. P.D. for 3L = Datum Dia. + .25

Product Number Example: **2AK1141** ——— BORE SIZE

Single Groove (FHP) Bored-To-Size Sheaves

Dimensions

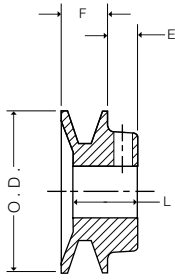

Type 1

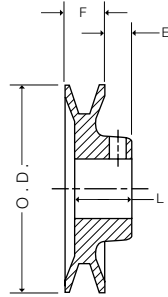

Type 2

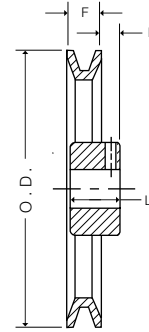

Type 3

DIMENSIONS (in inches)

Product No.	Datum Dia.		O.D.	Stock Bores	Max. Bore	Type	No. of Arms	Dimensions			Wt. Lbs.
	4L (A)	5L (B)						"E" Dim.	"F" Dim.	"L" Dim.	
BK19	-	1.70	2.05	5/8 - 3/4	7/8	1	N/A	7/16	13/16	1-3/32	0.6
BK20	-	1.80	2.15	1/2 - 5/8 - 3/4	1"	1	N/A	7/16	13/16	1-3/32	0.7
BK22	-	2.00	2.35	1/2 - 5/8 - 3/4 - 7/8 - 1	1"	1	N/A	7/16	13/16	1-3/32	0.8
BK23	-	2.10	2.45	1/2 - 5/8 - 3/4 - 7/8 - 1	1"	1	N/A	7/16	13/16	1-3/32	0.8
BK24	1.80	2.20	2.55	1/2 - 5/8 - 3/4 - 7/8 - 1	1"	1	N/A	7/16	13/16	1-3/32	0.9
BK25	1.90	2.30	2.65	1/2 - 5/8 - 3/4 - 7/8 - 1	1"	1	N/A	7/16	13/16	1-1/16	0.9
BK26	2.00	2.40	2.75	1/2 - 5/8 - 3/4 - 7/8	1"	1	N/A	7/16	13/16	1-1/16	1
BK27	2.10	2.50	2.85	1/2 - 5/8 - 3/4 - 7/8 - 1-1/8	1-1/8	2	N/A	7/16	13/16	1-1/16	1.1
BK28	2.20	2.60	2.95	1/2 - 5/8 - 3/4 - 7/8 - 1 - 1-1/8	1-1/8	2	N/A	7/16	13/16	1-1/16	1.1
BK30	2.40	2.80	3.15	1/2 - 5/8 - 3/4 - 7/8 - 1 - 1-1/8	1-1/8	2	N/A	7/16	13/16	1-1/16	1.3
BK31	2.50	2.90	3.25	1/2 - 5/8 - 3/4 - 7/8 - 1 - 1-1/8	1-1/8	2	N/A	7/16	13/16	1-3/32	1.3
BK32	2.60	3.00	3.35	1/2 - 5/8 - 3/4 - 7/8 - 1	1-1/8	2	N/A	7/16	13/16	1-1/16	1.3
BK34	2.80	3.20	3.55	1/2 - 5/8 - 3/4 - 7/8 - 1 - 1-1/8	1-1/8	2	N/A	7/16	7/8	1-5/32	1.6
BK36	3.00	3.40	3.75	1/2 - 5/8 - 3/4 - 7/8 - 1 - 1-1/8	1-1/8	2	N/A	7/16	7/8	1-5/32	1.7
BK40	3.20	3.60	3.95	1/2 - 5/8 - 3/4 - 7/8 - 1 - 1-1/8	1-1/8	2	N/A	7/16	7/8	1-5/32	1.8
BK45	3.50	3.90	4.25	1/2 - 5/8 - 3/4 - 7/8 - 1 - 1-1/8	1-1/8	2	N/A	7/16	7/8	1-5/32	2.1
BK46	3.60	4.00	4.35	7/8	1-1/8	2	N/A	7/16	7/8	1-5/32	2.1
BK47	3.70	4.10	4.45	1/2 - 5/8 - 3/4 - 7/8 - 1 - 1-1/8	1-5/16	2	N/A	7/16	7/8	1-5/32	2.4
BK48	3.80	4.20	4.55	5/8 - 3/4 - 7/8 - 1-1/8	1-5/16	2	N/A	7/16	7/8	1-5/32	2.4
BK50	4.00	4.40	4.75	1/2 - 5/8 - 3/4 - 7/8 - 15/16 - 1 - 1-1/8	1-1/8	3	3	7/16	7/8	1-5/32	2.0
BK52	4.20	4.60	4.95	1/2 - 5/8 - 3/4 - 7/8 - 1 - 1-1/8	1-1/8	3	3	7/16	7/8	1-5/32	2.2
BK55	4.50	4.90	5.25	1/2 - 5/8 - 3/4 - 7/8 - 1 - 1-1/8 - 1-3/16	1-5/16	3	3	7/16	7/8	1-5/32	2.5
BK57	4.70	5.10	5.45	5/8 - 3/4 - 7/8 - 15/16 - 1 - 1-1/8	1-5/16	3	3	7/16	7/8	1-5/32	2.6
BK60	5.00	5.40	5.75	1/2 - 5/8 - 3/4 - 7/8 - 1 - 1-1/8 - 1-3/16	1-3/8	3	3	7/16	7/8	1-5/32	2.7
BK62	5.20	5.60	5.95	1/2 - 5/8 - 3/4 - 7/8 - 15/16 - 1 - 1-1/8 - 1-3/16	1-9/16	3	3	7/16	7/8	1-5/32	3.2
BK65	5.50	5.90	6.25	5/8 - 3/4 - 1 - 1-1/8	1-9/16	3	3	7/16	7/8	1-5/32	3.3
BK67	5.70	6.10	6.45	5/8 - 3/4 - 1 - 1-1/8	1-9/16	3	3	7/16	7/8	1-5/32	3.6
BK70	6.00	6.40	6.75	5/8 - 3/4 - 15/16 - 1 - 1-1/8 - 1-3/16 - 1-7/16	1-11/16	3	3	21/32	7/8	1-5/32	4
BK72	6.20	6.60	6.95	3/4 - 1 - 1-1/8 - 1-3/8 - 1-7/16	1-11/16	3	3	21/32	7/8	1-15/32	4.1
BK75	6.50	6.90	7.25	3/4 - 1 - 1-1/8 - 1-7/16	1-11/16	3	6	21/32	7/8	1-15/32	4.5
BK77	6.70	7.10	7.45	3/4 - 1 - 1-1/8 - 1-3/8 - 1-7/16	1-11/16	3	6	21/32	7/8	1-15/32	4.5
BK80	7.00	7.40	7.75	5/8 - 3/4 - 7/8 - 1 - 1-1/8 - 1-3/16 - 1-1/4 - 1-3/8 - 1-7/16	1-11/16	3	6	21/32	7/8	1-15/32	4.8
BK85	7.50	7.90	8.25	3/4 - 1 - 1-1/8 - 1-3/16 - 1-3/8 - 1-7/16	1-11/16	3	6	21/32	7/8	1-15/32	5.1
BK90	8.00	8.40	8.75	5/8 - 3/4 - 7/8 - 15/16 - 1 - 1-1/8 - 1-3/16 - 1-3/8 - 1-7/16	1-11/16	3	6	21/32	7/8	1-15/32	5.4
BK95	8.50	8.90	9.25	3/4 - 1 - 1-1/8 - 1-3/8 - 1-7/16	1-11/16	3	6	21/32	7/8	1-15/32	5.6
BK100	9.00	9.40	9.75	3/4 - 7/8 - 15/16 - 1 - 1-1/8 - 1-3/16 - 1-1/4 - 1-3/8 - 1-7/16	1-11/16	3	6	21/32	7/8	1-15/32	6.2
BK105	9.50	9.90	10.25	1 - 1-3/8 - 1-7/16	1-11/16	3	6	21/32	7/8	1-15/32	6.3
BK110	10.00	10.40	10.75	3/4 - 1 - 1-1/8 - 1-3/16 - 1-3/8 - 1-7/16	1-11/16	3	6	21/32	7/8	1-15/32	6.6
BK115	10.50	10.90	11.25	1 - 1-3/8 - 1-7/16	1-11/16	3	6	21/32	7/8	1-15/32	7.2
BK120	11.00	11.40	11.75	3/4 - 1 - 1-3/16 - 1-3/8 - 1-7/16	1-11/16	3	6	21/32	7/8	1-15/32	7.5
BK130	12.00	12.40	12.75	3/4 - 1 - 1-1/8 - 1-3/16 - 1-1/4 - 1-7/16	1-11/16	3	6	21/32	7/8	1-15/32	8.5
BK140	13.00	13.40	13.75	3/4 - 1 - 1-1/8 - 1-3/16 - 1-7/16	1-11/16	3	6	21/32	7/8	1-15/32	9.8
BK160	15.00	15.40	15.75	1 - 1-1/8 - 1-3/16 - 1-1/4 - 1-7/16	1-11/16	3	6	21/32	7/8	1-15/32	11.2
BK190	18.00	18.40	18.75	1 - 1-3/16 - 1-1/4 - 1-7/16	1-11/16	3	6	21/32	7/8	1-15/32	13.4

◆ P.D. for A belts = Datum Dia. + .38
P.D. for B belts = Datum Dia. + .413

Product Number Example: **BK701516**
BORE SIZE

Standard Keyseat Dimensions

Shaft Dia.	Width	Depth
1/2	No Keyseat	
5/8 - 7/8	3/16	3/32
15/16 - 1-1/4	1/4	1/8
1-5/16 - 1-3/8	5/16	5/32
1-7/16 - 1-3/4	3/8	3/16

Two Groove (FHP) Bored-To-Size Sheaves

Dimensions

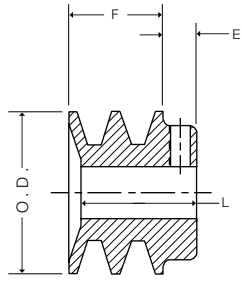

Type 1A

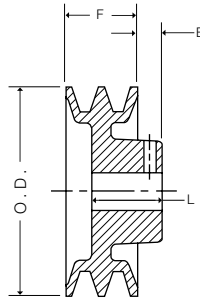

Type 2A

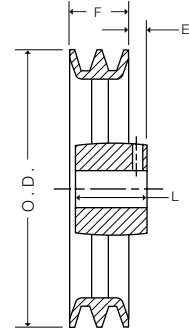

Type 3A

BTS SHEAVES FOR "B" BELTS

Product No.	Datum Dia.		O.D.	Stock Bores	Max. Bore	Type	No. of Arms	Dimensions			Wt. Lbs.
	4L (A)	5L (B)						"E" Dim.	"F" Dim.	"L" Dim.	
2BK23	1.70	2.10	2.45	5/8 - 7/8	1-1/8	1A	N/A	15/32	1-3/4	2-1/32	1.7
2BK25	1.90	2.30	2.65	1/2 - 5/8 - 3/4 - 7/8 - 1	1-1/8	1A	N/A	15/32	1-3/4	1-31/32	1.8
2BK26	2.00	2.40	2.75	5/8 - 7/8 - 1-1/8	1-1/8	1A	N/A	15/32	1-3/4	1-31/32	2.0
2BK27	2.10	2.50	2.85	1/2 - 5/8 - 3/4 - 7/8 - 1 - 1-1/8	1-1/8	1A	N/A	15/32	1-3/4	1-31/32	2.1
2BK28	2.20	2.60	2.95	1/2 - 5/8 - 3/4 - 7/8 - 1 - 1-1/8	1-1/8	1A	N/A	15/32	1-3/4	1-31/32	2.2
2BK30	2.40	2.80	3.15	1/2 - 5/8 - 3/4 - 7/8 - 1 - 1-1/8	1-1/8	1A	N/A	15/32	1-3/4	1-31/32	2.6
2BK32	2.60	3.00	3.35	5/8 - 3/4 - 7/8 - 1 - 1-1/8	1-1/8	1A	N/A	15/32	1-3/4	1-31/32	2.9
2BK34	2.80	3.20	3.55	5/8 - 3/4 - 7/8 - 1 - 1-1/8	1-1/8	1A	N/A	15/32	1-3/4	1-31/32	3.3
2BK36	3.00	3.40	3.75	5/8 - 3/4 - 7/8 - 1 - 1-1/8 - 1-3/8	1-3/8	1A	N/A	15/32	1-3/4	1-31/32	3.7
2BK40	3.20	3.60	3.95	5/8 - 3/4 - 7/8 - 1 - 1-1/8 - 1-3/8	1-3/8	2A	N/A	15/32	1-3/4	1-15/32	3.3
2BK45	3.50	3.90	4.25	1 - 1-1/8 - 1-3/8	1-3/8	2A	N/A	15/32	1-3/4	1-15/32	3.9
2BK47	3.70	4.10	4.45	7/8 - 1 - 1-1/8	1-3/8	2A	N/A	15/32	1-3/4	1-15/32	4.2
2BK50	4.00	4.40	4.75	3/4 - 1 - 1-1/8 - 1-3/8	1-3/8	2A	N/A	15/32	1-3/4	1-15/32	4.7
2BK52	4.20	4.60	4.95	7/8 - 1 - 1-1/8 - 1-3/8	1-3/8	2A	N/A	15/32	1-3/4	1-15/32	5.0
2BK55	4.50	4.90	5.25	1-1/8 - 1-3/8	1-7/16	2A	N/A	15/32	1-3/4	1-15/32	5.1
2BK57	4.70	5.10	5.45	1 - 1-1/8 - 1-3/8	1-7/16	2A	N/A	15/32	1-3/4	1-15/32	4.8
2BK60	5.00	5.40	5.75	3/4 - 7/8 - 1 - 1-1/8 - 1-3/8	1-7/16	3A	3	15/32	1-3/4	1-15/32	5.3
2BK62	5.20	5.60	5.95	1 - 1-1/8 - 1-3/8	1-7/16	3A	3	15/32	1-3/4	1-15/32	5.7
2BK65	5.50	5.90	6.25	1 - 1-1/8 - 1-3/8	1-7/16	3A	3	15/32	1-3/4	1-15/32	5.5
2BK67	5.70	6.10	6.45	1 - 1-1/8 - 1-3/8	1-7/16	3A	3	15/32	1-3/4	1-15/32	5.7
2BK70	6.00	6.40	6.75	3/4 - 1 - 1-1/8 - 1-3/16 - 1-3/8 - 1-7/16	1-11/16	3A	3	11/32	1-3/4	1-19/32	6.5
2BK80	7.00	7.40	7.75	3/4 - 1 - 1-1/8 - 1-3/16 - 1-3/8 - 1-7/16	1-11/16	3A	6	11/32	1-3/4	1-19/32	7.9
2BK90	8.00	8.40	8.75	3/4 - 1 - 1-1/8 - 1-3/16 - 1-3/8 - 1-7/16	1-11/16	3A	6	11/32	1-3/4	1-19/32	8.9
2BK100	9.00	9.40	9.75	3/4 - 1 - 1-3/16 - 1-3/8 - 1-7/16	1-11/16	3A	6	11/32	1-3/4	1-19/32	10.1
2BK110	10.00	10.40	10.75	1 - 1-3/16 - 1-7/16	1-11/16	3A	6	11/32	1-3/4	1-19/32	11.1
2BK120	11.00	11.40	11.75	1 - 1-3/16 - 1-7/16	1-11/16	3A	6	11/32	1-3/4	1-19/32	12.2
2BK130	12.00	12.40	12.75	1 - 1-3/16 - 1-7/16	1-15/16	3A	6	11/32	1-3/4	1-19/32	14.0
2BK140	13.00	13.40	13.75	1 - 1-3/16 - 1-7/16	1-15/16	3A	6	11/32	1-3/4	1-19/32	15.1
2BK160	15.00	15.40	15.75	1 - 1-3/16 - 1-7/16	1-15/16	3A	6	11/32	1-3/4	1-19/32	17.9
2BK190	18.00	18.40	18.75	1-3/16 - 1-7/16	1-15/16	3A	6	11/32	1-3/4	1-19/32	22.0

- ◆ P.D. for A belts = Datum Dia. + .38
- P.D. for B belts = Datum Dia. + .413

Product Number Example: **2BK30118**
└─── BORE SIZE

Standard Keyseat Dimensions

Shaft Dia.	Width	Depth
1/2	No Keyseat	
5/8 - 7/8	3/16	3/32
15/16 - 1-1/4	1/4	1/8
1-5/16 - 1-3/8	5/16	5/32
1-7/16 - 1-3/4	3/8	3/16

Light-Duty (FHP) V-Belts

Dimensions

5L Belts

Product No.	Outside Length	Wt. (Lbs.)
5L230	23.0	.18
5L240	24.0	.19
5L250	25.0	.20
5L260	26.0	.20
5L270	27.0	.21
5L280	28.0	.22
5L290	29.0	.23
5L300	30.0	.23
5L310	31.0	.24
5L320	32.0	.25
5L330	33.0	.26
5L340	34.0	.27
5L350	35.0	.27
5L360	36.0	.28
5L370	37.0	.29
5L380	38.0	.30
5L390	39.0	.31
5L400	40.0	.31
5L410	41.0	.32
5L420	42.0	.33
5L430	43.0	.34
5L440	44.0	.35
5L450	45.0	.35
5L460	46.0	.36
5L470	47.0	.37
5L480	48.0	.38
5L490	49.0	.39
5L500	50.0	.39
5L510	51.0	.40
5L520	52.0	.41
5L530	53.0	.42
5L540	54.0	.43
5L550	55.0	.43
5L560	56.0	.44
5L570	57.0	.45

Product No.	Outside Length	Wt. (Lbs.)
5L580	58.0	.46
5L590	59.0	.47
5L600	60.0	.47
5L610	61.0	.48
5L620	62.0	.49
5L630	63.0	.50
5L640	64.0	.51
5L650	65.0	.51
5L660	66.0	.52
5L670	67.0	.53
5L680	68.0	.54
5L690	69.0	.55
5L700	70.0	.55
5L710	71.0	.56
5L720	72.0	.57
5L730	73.0	.58
5L740	74.0	.59
5L750	75.0	.59
5L760	76.0	.60
5L770	77.0	.61
5L780	78.0	.62
5L790	79.0	.63
5L800	80.0	.63
5L810	81.0	.64
5L820	82.0	.65
5L830	83.0	.66
5L840	84.0	.67
5L850	85.0	.67

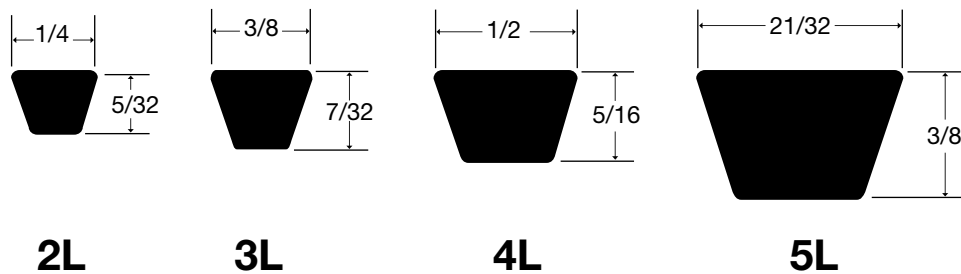

Drive Ratios Using 3L Belts In AK Sheaves

Ratio	DR	DN	Ratio	DR	DN	Ratio	DR	DN	Ratio	DR	DN	Ratio	DR	DN
1.00	AK20	AK20	1.18	AK44	AK51	1.44	AK46	AK64	1.74	AK34	AK59	2.07	AK30	AK61
1.00	AK21	AK21	1.18	AK30	AK35	1.44	AK28	AK41	1.75	AK35	AK61	2.09	AK25	AK51
1.00	AK22	AK22	1.19	AK24	AK28	1.44	AK39	AK54	1.76	AK32	AK56	2.09	AK24	AK49
1.00	AK23	AK23	1.19	AK46	AK54	1.44	AK30	AK44	1.76	AK28	AK49	2.09	AK46	AK91
1.00	AK24	AK24	1.20	AK23	AK27	1.45	AK23	AK32	1.77	AK44	AK74	2.10	AK32	AK66
1.00	AK25	AK25	1.21	AK39	AK46	1.45	AK25	AK35	1.77	AK25	AK44	2.11	AK41	AK81
1.00	AK26	AK26	1.21	AK27	AK32	1.47	AK20	AK28	1.77	AK21	AK35	2.11	AK20	AK41
1.00	AK27	AK27	1.21	AK22	AK26	1.47	AK24	AK34	1.78	AK41	AK69	2.12	AK27	AK56
1.00	AK28	AK28	1.22	AK35	AK44	1.48	AK26	AK39	1.78	AK26	AK46	2.13	AK34	AK71
1.00	AK30	AK30	1.22	AK21	AK25	1.48	AK34	AK51	1.79	AK22	AK39	2.13	AK26	AK54
1.00	AK32	AK32	1.22	AK41	AK49	1.49	AK46	AK66	1.79	AK39	AK66	2.15	AK44	AK89
1.00	AK34	AK34	1.23	AK25	AK30	1.50	AK21	AK30	1.80	AK23	AK41	2.15	AK22	AK46
1.00	AK35	AK35	1.23	AK20	AK24	1.50	AK27	AK41	1.80	AK46	AK79	2.15	AK35	AK74
1.00	AK39	AK39	1.24	AK28	AK34	1.50	AK39	AK56	1.80	AK34	AK61	2.16	AK28	AK59
1.00	AK41	AK41	1.24	AK32	AK41	1.50	AK41	AK59	1.81	AK30	AK54	2.16	AK21	AK44
1.00	AK44	AK44	1.24	AK46	AK56	1.51	AK44	AK64	1.82	AK20	AK34	2.17	AK46	AK94
1.00	AK46	AK46	1.25	AK23	AK28	1.52	AK32	AK49	1.83	AK27	AK49	2.17	AK39	AK79
1.03	AK34	AK35	1.26	AK44	AK54	1.52	AK30	AK46	1.83	AK41	AK71	2.18	AK30	AK64
1.04	AK27	AK28	1.26	AK34	AK44	1.52	AK24	AK35	1.84	AK28	AK51	2.18	AK24	AK51
1.04	AK26	AK27	1.26	AK30	AK39	1.52	AK22	AK32	1.84	AK35	AK64	2.19	AK41	AK84
1.05	AK25	AK26	1.26	AK26	AK32	1.53	AK35	AK54	1.85	AK46	AK81	2.19	AK23	AK49
1.05	AK24	AK25	1.26	AK22	AK27	1.54	AK25	AK39	1.85	AK24	AK44	2.20	AK44	AK91
1.05	AK23	AK24	1.28	AK21	AK26	1.55	AK23	AK34	1.86	AK32	AK59	2.20	AK32	AK69
1.05	AK44	AK46	1.28	AK41	AK51	1.55	AK41	AK61	1.86	AK25	AK46	2.21	AK26	AK56
1.05	AK22	AK23	1.28	AK28	AK35	1.56	AK28	AK44	1.88	AK20	AK35	2.22	AK25	AK54
1.06	AK21	AK22	1.28	AK35	AK46	1.56	AK46	AK69	1.88	AK39	AK69	2.22	AK34	AK74
1.06	AK20	AK21	1.28	AK24	AK30	1.56	AK44	AK66	1.88	AK21	AK39	2.23	AK39	AK81
1.06	AK39	AK41	1.29	AK27	AK34	1.56	AK26	AK41	1.89	AK30	AK56	2.24	AK28	AK61
1.06	AK35	AK39	1.29	AK20	AK25	1.58	AK34	AK54	1.89	AK22	AK41	2.24	AK27	AK59
1.07	AK32	AK34	1.29	AK39	AK49	1.58	AK32	AK51	1.90	AK44	AK79	2.25	AK30	AK66
1.07	AK46	AK49	1.31	AK44	AK56	1.58	AK20	AK30	1.90	AK34	AK64	2.27	AK21	AK46
1.07	AK30	AK32	1.31	AK22	AK28	1.59	AK39	AK59	1.90	AK35	AK66	2.27	AK32	AK71
1.08	AK28	AK30	1.32	AK46	AK59	1.59	AK35	AK56	1.91	AK26	AK49	2.28	AK44	AK94
1.08	AK41	AK44	1.32	AK25	AK32	1.60	AK23	AK35	1.91	AK27	AK51	2.29	AK20	AK44
1.09	AK26	AK28	1.32	AK34	AK46	1.61	AK21	AK32	1.91	AK41	AK74	2.29	AK46	AK99
1.09	AK25	AK27	1.33	AK21	AK27	1.61	AK46	AK71	1.92	AK46	AK84	2.29	AK23	AK51
1.09	AK24	AK26	1.33	AK27	AK35	1.62	AK24	AK39	1.93	AK32	AK61	2.31	AK35	AK79
1.10	AK34	AK39	1.33	AK30	AK41	1.62	AK27	AK44	1.94	AK39	AK71	2.31	AK22	AK49
1.10	AK23	AK25	1.34	AK32	AK44	1.63	AK30	AK49	1.95	AK23	AK44	2.31	AK25	AK56
1.10	AK32	AK35	1.35	AK26	AK34	1.63	AK22	AK34	1.95	AK44	AK81	2.32	AK39	AK84
1.10	AK22	AK24	1.35	AK23	AK30	1.63	AK25	AK41	1.95	AK24	AK46	2.33	AK24	AK54
1.11	AK21	AK23	1.35	AK20	AK26	1.64	AK41	AK64	1.96	AK28	AK54	2.33	AK27	AK61
1.12	AK20	AK22	1.35	AK39	AK51	1.64	AK28	AK46	1.96	AK34	AK66	2.33	AK41	AK89
1.12	AK46	AK51	1.36	AK28	AK39	1.64	AK44	AK69	1.99	AK20	AK39	2.34	AK26	AK59
1.12	AK27	AK30	1.36	AK41	AK54	1.64	AK34	AK56	1.99	AK21	AK41	2.35	AK28	AK64
1.12	AK35	AK41	1.36	AK46	AK61	1.65	AK39	AK61	2.00	AK25	AK49	2.37	AK30	AK69
1.13	AK44	AK49	1.37	AK35	AK49	1.68	AK22	AK35	2.00	AK26	AK51	2.37	AK35	AK81
1.14	AK25	AK28	1.38	AK24	AK32	1.68	AK46	AK74	2.00	AK30	AK59	2.37	AK32	AK74
1.14	AK41	AK46	1.38	AK44	AK59	1.69	AK35	AK59	2.00	AK35	AK69	2.38	AK34	AK79
1.14	AK24	AK27	1.39	AK21	AK28	1.69	AK32	AK54	2.02	AK44	AK84	2.39	AK41	AK91
1.15	AK39	AK44	1.39	AK26	AK35	1.69	AK44	AK71	2.03	AK39	AK74	2.40	AK20	AK46
1.15	AK30	AK34	1.41	AK25	AK34	1.69	AK41	AK66	2.03	AK32	AK64	2.41	AK44	AK99
1.15	AK23	AK26	1.41	AK20	AK27	1.69	AK26	AK44	2.04	AK28	AK56	2.41	AK46	AK104
1.16	AK22	AK25	1.41	AK32	AK46	1.70	AK23	AK39	2.04	AK27	AK54	2.41	AK22	AK51
1.16	AK28	AK32	1.41	AK27	AK39	1.70	AK30	AK51	2.04	AK23	AK46	2.42	AK24	AK56
1.16	AK34	AK41	1.42	AK41	AK56	1.70	AK20	AK32	2.05	AK46	AK89	2.43	AK26	AK61
1.17	AK21	AK24	1.42	AK34	AK49	1.71	AK27	AK46	2.05	AK22	AK44	2.43	AK28	AK66
1.17	AK32	AK39	1.42	AK22	AK30	1.71	AK24	AK41	2.05	AK41	AK79	2.44	AK21	AK49
1.17	AK26	AK30	1.43	AK44	AK61	1.72	AK21	AK34	2.06	AK35	AK71	2.44	AK30	AK71
1.18	AK20	AK23	1.44	AK35	AK51	1.73	AK39	AK64	2.06	AK34	AK69	2.44	AK23	AK54

Drive Ratios Using 3L Belts In AK Sheaves

Ratio	DR	DN	Ratio	DR	DN	Ratio	DR	DN	Ratio	DR	DN	Ratio	DR	DN
2.45	AK34	AK81	2.89	AK32	AK89	3.42	AK26	AK84	4.11	AK27	AK104	5.20	AK21	AK99
2.45	AK25	AK59	2.90	AK24	AK66	3.43	AK28	AK91	4.13	AK41	AK154	5.21	AK20	AK94
2.45	AK27	AK64	2.90	AK46	AK124	3.44	AK23	AK74	4.14	AK22	AK84	5.25	AK39	AK184
2.46	AK35	AK84	2.90	AK25	AK69	3.44	AK25	AK81	4.15	AK28	AK109	5.36	AK27	AK134
2.47	AK39	AK89	2.91	AK39	AK104	3.46	AK20	AK64	4.15	AK34	AK134	5.39	AK25	AK124
2.47	AK41	AK94	2.92	AK30	AK84	3.46	AK22	AK71	4.18	AK23	AK89	5.43	AK23	AK114
2.52	AK39	AK91	2.93	AK35	AK99	3.47	AK30	AK99	4.20	AK21	AK81	5.45	AK22	AK109
2.53	AK46	AK109	2.94	AK22	AK61	3.49	AK27	AK89	4.22	AK24	AK94	5.48	AK21	AK104
2.53	AK44	AK104	2.94	AK23	AK64	3.49	AK39	AK124	4.26	AK25	AK99	5.50	AK30	AK154
2.54	AK27	AK66	2.95	AK28	AK79	3.51	AK34	AK114	4.28	AK23	AK91	5.50	AK20	AK99
2.54	AK25	AK61	2.96	AK32	AK91	3.51	AK24	AK79	4.29	AK26	AK104	5.54	AK28	AK144
2.54	AK23	AK56	2.99	AK20	AK56	3.54	AK21	AK69	4.32	AK27	AK109	5.58	AK35	AK184
2.54	AK34	AK84	2.99	AK21	AK59	3.55	AK28	AK94	4.33	AK20	AK79	5.59	AK26	AK134
2.55	AK32	AK79	2.99	AK25	AK71	3.56	AK44	AK144	4.33	AK35	AK144	5.64	AK24	AK124
2.55	AK21	AK51	2.99	AK26	AK74	3.57	AK27	AK91	4.35	AK28	AK114	5.71	AK22	AK114
2.55	AK30	AK74	3.02	AK41	AK114	3.57	AK20	AK66	4.36	AK46	AK184	5.75	AK21	AK109
2.55	AK28	AK69	3.03	AK34	AK99	3.58	AK41	AK134	4.37	AK21	AK84	5.76	AK34	AK184
2.56	AK26	AK64	3.03	AK28	AK81	3.58	AK32	AK109	4.37	AK39	AK154	5.77	AK27	AK144
2.56	AK24	AK59	3.04	AK24	AK69	3.58	AK25	AK84	4.39	AK30	AK124	5.80	AK20	AK104
2.57	AK22	AK54	3.04	AK23	AK66	3.61	AK24	AK81	4.40	AK22	AK89	5.84	AK25	AK134
2.58	AK20	AK49	3.05	AK44	AK124	3.62	AK22	AK74	4.43	AK23	AK94	5.93	AK23	AK124
2.61	AK41	AK99	3.05	AK39	AK109	3.63	AK46	AK154	4.44	AK32	AK134	5.94	AK28	AK154
2.61	AK39	AK94	3.06	AK32	AK94	3.64	AK26	AK89	4.45	AK20	AK81	6.02	AK26	AK144
2.62	AK32	AK81	3.07	AK27	AK79	3.65	AK21	AK71	4.46	AK24	AK99	6.03	AK21	AK114
2.62	AK35	AK89	3.09	AK35	AK104	3.66	AK30	AK104	4.47	AK34	AK144	6.09	AK20	AK109
2.63	AK28	AK71	3.09	AK22	AK64	3.69	AK23	AK79	4.48	AK25	AK104	6.12	AK24	AK134
2.65	AK26	AK66	3.10	AK21	AK61	3.70	AK27	AK94	4.51	AK26	AK109	6.15	AK32	AK184
2.65	AK46	AK114	3.10	AK30	AK89	3.71	AK35	AK124	4.51	AK22	AK91	6.19	AK27	AK154
2.66	AK24	AK61	3.13	AK25	AK74	3.73	AK26	AK91	4.53	AK27	AK114	6.24	AK22	AK124
2.66	AK27	AK69	3.13	AK24	AK71	3.75	AK20	AK69	4.58	AK44	AK184	6.29	AK25	AK144
2.66	AK44	AK109	3.14	AK46	AK134	3.75	AK24	AK84	4.63	AK20	AK84	6.38	AK20	AK114
2.67	AK25	AK64	3.15	AK28	AK84	3.75	AK28	AK99	4.64	AK35	AK154	6.42	AK23	AK134
2.68	AK22	AK56	3.16	AK27	AK81	3.75	AK32	AK114	4.65	AK21	AK89	6.45	AK26	AK154
2.68	AK35	AK91	3.16	AK20	AK59	3.79	AK39	AK134	4.66	AK22	AK94	6.58	AK21	AK124
2.69	AK23	AK59	3.18	AK30	AK91	3.79	AK23	AK81	4.68	AK23	AK99	6.59	AK24	AK144
2.70	AK20	AK51	3.19	AK34	AK104	3.81	AK25	AK89	4.70	AK24	AK104	6.61	AK30	AK184
2.70	AK34	AK89	3.19	AK23	AK69	3.81	AK44	AK154	4.71	AK25	AK109	6.75	AK25	AK154
2.71	AK21	AK54	3.20	AK22	AK66	3.82	AK21	AK74	4.72	AK26	AK114	6.76	AK22	AK134
2.72	AK32	AK84	3.20	AK39	AK114	3.83	AK34	AK124	4.75	AK28	AK124	6.92	AK23	AK144
2.73	AK30	AK79	3.21	AK26	AK79	3.84	AK30	AK109	4.76	AK21	AK91	6.96	AK20	AK124
2.74	AK27	AK71	3.23	AK32	AK99	3.85	AK41	AK144	4.76	AK30	AK134	7.07	AK24	AK154
2.75	AK41	AK104	3.24	AK35	AK109	3.86	AK26	AK94	4.78	AK32	AK144	7.13	AK21	AK134
2.75	AK28	AK74	3.27	AK21	AK64	3.87	AK20	AK71	4.79	AK34	AK154	7.14	AK28	AK184
2.76	AK39	AK99	3.27	AK24	AK74	3.88	AK22	AK79	4.92	AK20	AK89	7.28	AK22	AK144
2.76	AK25	AK66	3.28	AK20	AK61	3.90	AK25	AK91	4.92	AK21	AK94	7.42	AK23	AK154
2.77	AK34	AK91	3.28	AK27	AK84	3.90	AK27	AK99	4.93	AK22	AK99	7.43	AK27	AK184
2.77	AK26	AK69	3.29	AK30	AK94	3.94	AK23	AK84	4.93	AK23	AK104	7.55	AK20	AK134
2.78	AK35	AK94	3.29	AK23	AK71	3.95	AK28	AK104	4.93	AK24	AK109	7.69	AK21	AK144
2.79	AK44	AK114	3.29	AK26	AK81	3.98	AK22	AK81	4.94	AK25	AK114	7.75	AK26	AK184
2.79	AK23	AK61	3.30	AK41	AK124	3.99	AK24	AK89	4.94	AK27	AK124	7.81	AK22	AK154
2.80	AK24	AK64	3.30	AK44	AK134	4.02	AK35	AK134	4.96	AK41	AK184	8.10	AK25	AK184
2.81	AK30	AK81	3.35	AK34	AK109	4.03	AK30	AK114	5.04	AK20	AK91	8.13	AK20	AK144
2.82	AK21	AK56	3.35	AK28	AK89	4.03	AK25	AK94	5.12	AK32	AK154	8.24	AK21	AK154
2.83	AK22	AK59	3.35	AK25	AK79	4.04	AK20	AK74	5.13	AK30	AK144	8.49	AK24	AK184
2.86	AK26	AK71	3.36	AK22	AK69	4.07	AK26	AK99	5.14	AK28	AK134	8.72	AK20	AK154
2.86	AK34	AK94	3.38	AK21	AK66	4.08	AK39	AK144	5.16	AK26	AK124	8.91	AK23	AK184
2.87	AK27	AK74	3.38	AK46	AK144	4.08	AK24	AK91	5.17	AK24	AK114	9.38	AK22	AK184
2.87	AK20	AK54	3.40	AK35	AK114	4.09	AK32	AK124	5.18	AK23	AK109	9.90	AK21	AK184
2.88	AK41	AK109	3.41	AK32	AK104	4.09	AK21	AK79	5.19	AK22	AK104	10.47	AK20	AK184

Drive Ratios Using 4L, AP & AX Belts In AK Sheaves

Ratio	DR	DN	Ratio	DR	DN	Ratio	DR	DN	Ratio	DR	DN	Ratio	DR	DN
1.00	AK15	AK15	1.05	AK61	AK64	1.13	AK41	AK46	1.21	AK49	AK59	1.30	AK26	AK34
1.00	AK16	AK16	1.05	AK19	AK20	1.13	AK23	AK26	1.21	AK23	AK28	1.30	AK61	AK79
1.00	AK17	AK17	1.05	AK39	AK41	1.13	AK15	AK17	1.22	AK32	AK41	1.30	AK84	AK109
1.00	AK18	AK18	1.05	AK18	AK19	1.13	AK79	AK89	1.22	AK18	AK22	1.30	AK16	AK21
1.00	AK19	AK19	1.05	AK94	AK99	1.13	AK30	AK34	1.22	AK94	AK114	1.30	AK51	AK66
1.00	AK20	AK20	1.06	AK56	AK59	1.13	AK22	AK25	1.22	AK61	AK74	1.31	AK19	AK25
1.00	AK21	AK21	1.06	AK35	AK39	1.13	AK39	AK44	1.22	AK22	AK27	1.31	AK32	AK44
1.00	AK22	AK22	1.06	AK17	AK18	1.13	AK54	AK61	1.22	AK69	AK84	1.32	AK28	AK39
1.00	AK23	AK23	1.06	AK89	AK94	1.13	AK61	AK69	1.22	AK46	AK56	1.32	AK49	AK64
1.00	AK24	AK24	1.06	AK84	AK89	1.14	AK74	AK84	1.23	AK26	AK32	1.32	AK39	AK51
1.00	AK25	AK25	1.06	AK16	AK17	1.14	AK21	AK24	1.23	AK81	AK99	1.32	AK64	AK84
1.00	AK26	AK26	1.06	AK51	AK54	1.14	AK28	AK32	1.23	AK54	AK66	1.32	AK15	AK20
1.00	AK27	AK27	1.06	AK32	AK34	1.14	AK71	AK81	1.23	AK89	AK109	1.32	AK79	AK104
1.00	AK28	AK28	1.06	AK15	AK16	1.14	AK34	AK41	1.23	AK17	AK21	1.32	AK54	AK71
1.00	AK30	AK30	1.06	AK79	AK84	1.15	AK91	AK104	1.23	AK30	AK39	1.32	AK18	AK24
1.00	AK32	AK32	1.07	AK30	AK32	1.15	AK20	AK23	1.23	AK34	AK44	1.32	AK94	AK124
1.00	AK34	AK34	1.07	AK46	AK49	1.15	AK56	AK64	1.23	AK21	AK26	1.33	AK21	AK28
1.00	AK35	AK35	1.07	AK74	AK79	1.15	AK49	AK56	1.23	AK66	AK81	1.33	AK69	AK91
1.00	AK39	AK39	1.07	AK28	AK30	1.15	AK69	AK79	1.23	AK74	AK91	1.33	AK24	AK32
1.00	AK41	AK41	1.07	AK69	AK74	1.15	AK26	AK30	1.24	AK44	AK54	1.33	AK41	AK54
1.00	AK44	AK44	1.08	AK26	AK28	1.15	AK19	AK22	1.24	AK56	AK69	1.33	AK56	AK74
1.00	AK46	AK46	1.08	AK41	AK44	1.15	AK32	AK39	1.24	AK64	AK79	1.33	AK71	AK94
1.00	AK49	AK49	1.08	AK66	AK71	1.15	AK79	AK91	1.24	AK16	AK20	1.34	AK61	AK81
1.00	AK51	AK51	1.08	AK25	AK27	1.16	AK64	AK74	1.24	AK84	AK104	1.34	AK46	AK61
1.00	AK54	AK54	1.08	AK64	AK69	1.16	AK51	AK59	1.24	AK20	AK25	1.34	AK35	AK49
1.00	AK56	AK56	1.08	AK24	AK26	1.16	AK18	AK21	1.24	AK24	AK30	1.34	AK26	AK35
1.00	AK59	AK59	1.08	AK61	AK66	1.16	AK94	AK109	1.25	AK28	AK35	1.34	AK20	AK27
1.00	AK61	AK61	1.08	AK84	AK91	1.16	AK24	AK28	1.25	AK49	AK61	1.34	AK17	AK23
1.00	AK64	AK64	1.09	AK23	AK25	1.16	AK81	AK94	1.25	AK41	AK51	1.34	AK74	AK99
1.00	AK66	AK66	1.09	AK34	AK39	1.16	AK30	AK35	1.25	AK35	AK46	1.35	AK59	AK79
1.00	AK69	AK69	1.09	AK59	AK64	1.16	AK44	AK51	1.25	AK27	AK34	1.35	AK81	AK109
1.00	AK71	AK71	1.09	AK22	AK24	1.17	AK61	AK71	1.26	AK19	AK24	1.35	AK44	AK59
1.00	AK74	AK74	1.09	AK91	AK99	1.17	AK23	AK27	1.26	AK91	AK114	1.35	AK25	AK34
1.00	AK79	AK79	1.09	AK56	AK61	1.17	AK17	AK20	1.26	AK79	AK99	1.36	AK22	AK30
1.00	AK81	AK81	1.09	AK32	AK35	1.17	AK89	AK104	1.26	AK15	AK19	1.36	AK66	AK89
1.00	AK84	AK84	1.09	AK21	AK23	1.17	AK59	AK69	1.26	AK71	AK89	1.36	AK49	AK66
1.00	AK89	AK89	1.10	AK54	AK59	1.18	AK22	AK26	1.26	AK59	AK74	1.36	AK19	AK26
1.00	AK91	AK91	1.10	AK74	AK81	1.18	AK69	AK81	1.26	AK51	AK64	1.36	AK16	AK22
1.00	AK94	AK94	1.10	AK20	AK22	1.18	AK46	AK54	1.27	AK22	AK28	1.36	AK27	AK39
1.02	AK89	AK91	1.10	AK81	AK89	1.18	AK27	AK32	1.27	AK39	AK49	1.36	AK51	AK69
1.03	AK79	AK81	1.10	AK51	AK56	1.18	AK84	AK99	1.27	AK18	AK23	1.36	AK84	AK114
1.03	AK34	AK35	1.10	AK19	AK21	1.18	AK16	AK19	1.27	AK64	AK81	1.37	AK91	AK124
1.03	AK69	AK71	1.11	AK49	AK54	1.18	AK56	AK66	1.27	AK25	AK32	1.37	AK32	AK46
1.03	AK64	AK66	1.11	AK18	AK20	1.19	AK21	AK25	1.28	AK56	AK71	1.37	AK69	AK94
1.03	AK91	AK94	1.11	AK94	AK104	1.19	AK39	AK46	1.28	AK74	AK94	1.38	AK34	AK49
1.03	AK59	AK61	1.11	AK27	AK30	1.19	AK71	AK84	1.28	AK21	AK27	1.38	AK18	AK25
1.04	AK27	AK28	1.11	AK64	AK71	1.19	AK54	AK64	1.28	AK66	AK84	1.38	AK41	AK56
1.04	AK26	AK27	1.11	AK46	AK51	1.19	AK15	AK18	1.28	AK44	AK56	1.38	AK54	AK74
1.04	AK81	AK84	1.11	AK35	AK41	1.19	AK79	AK94	1.29	AK17	AK22	1.38	AK59	AK81
1.04	AK54	AK56	1.11	AK17	AK19	1.20	AK20	AK24	1.29	AK54	AK69	1.38	AK23	AK32
1.04	AK25	AK26	1.11	AK89	AK99	1.20	AK25	AK30	1.29	AK89	AK114	1.39	AK28	AK41
1.04	AK24	AK25	1.12	AK71	AK79	1.20	AK35	AK44	1.29	AK71	AK91	1.39	AK61	AK84
1.04	AK49	AK51	1.12	AK25	AK28	1.20	AK91	AK109	1.29	AK81	AK104	1.39	AK79	AK109
1.04	AK23	AK24	1.12	AK44	AK49	1.20	AK66	AK79	1.29	AK34	AK46	1.39	AK15	AK21
1.04	AK71	AK74	1.12	AK16	AK18	1.20	AK51	AK61	1.29	AK27	AK35	1.39	AK66	AK91
1.04	AK22	AK23	1.12	AK84	AK94	1.20	AK41	AK49	1.29	AK46	AK59	1.39	AK20	AK28
1.05	AK21	AK22	1.12	AK59	AK66	1.21	AK19	AK23	1.29	AK20	AK26	1.39	AK25	AK35
1.05	AK66	AK69	1.12	AK24	AK27	1.21	AK74	AK89	1.30	AK30	AK41	1.39	AK30	AK44
1.05	AK44	AK46	1.12	AK66	AK74	1.21	AK59	AK71	1.30	AK69	AK89	1.39	AK35	AK51
1.05	AK20	AK21	1.13	AK81	AK91	1.21	AK28	AK34	1.30	AK23	AK30	1.40	AK17	AK24

Drive Ratios Using 4L, AP & AX Belts In AK Sheaves

Ratio	DR	DN	Ratio	DR	DN	Ratio	DR	DN	Ratio	DR	DN	Ratio	DR	DN
1.40	AK39	AK54	1.51	AK54	AK81	1.63	AK46	AK74	1.76	AK54	AK94	1.92	AK32	AK64
1.40	AK44	AK61	1.51	AK89	AK134	1.63	AK49	AK79	1.76	AK71	AK124	1.93	AK20	AK41
1.40	AK64	AK89	1.51	AK17	AK26	1.63	AK41	AK66	1.77	AK51	AK89	1.93	AK39	AK74
1.40	AK89	AK124	1.52	AK15	AK23	1.64	AK44	AK71	1.77	AK19	AK34	1.94	AK24	AK49
1.40	AK71	AK99	1.52	AK46	AK69	1.64	AK61	AK99	1.77	AK32	AK59	1.94	AK25	AK51
1.40	AK51	AK71	1.52	AK44	AK66	1.64	AK64	AK104	1.77	AK15	AK27	1.94	AK44	AK84
1.40	AK46	AK64	1.52	AK69	AK104	1.64	AK56	AK91	1.78	AK59	AK104	1.95	AK49	AK94
1.41	AK24	AK34	1.52	AK34	AK54	1.65	AK15	AK25	1.79	AK46	AK81	1.95	AK30	AK61
1.41	AK19	AK27	1.52	AK59	AK89	1.65	AK18	AK30	1.79	AK30	AK56	1.95	AK54	AK104
1.41	AK74	AK104	1.52	AK32	AK51	1.65	AK94	AK154	1.79	AK56	AK99	1.96	AK34	AK69
1.42	AK26	AK39	1.53	AK49	AK74	1.65	AK21	AK35	1.79	AK26	AK49	1.96	AK59	AK114
1.42	AK81	AK114	1.53	AK24	AK39	1.67	AK16	AK27	1.79	AK81	AK144	1.96	AK35	AK71
1.42	AK21	AK30	1.53	AK22	AK34	1.67	AK19	AK32	1.80	AK27	AK51	1.96	AK64	AK124
1.42	AK49	AK69	1.53	AK39	AK59	1.67	AK22	AK39	1.80	AK39	AK69	1.96	AK41	AK79
1.42	AK56	AK79	1.54	AK35	AK56	1.67	AK25	AK44	1.80	AK64	AK114	1.96	AK69	AK134
1.42	AK16	AK23	1.54	AK18	AK28	1.67	AK28	AK49	1.81	AK61	AK109	1.97	AK74	AK144
1.43	AK64	AK91	1.54	AK94	AK144	1.67	AK34	AK59	1.81	AK51	AK91	1.97	AK46	AK89
1.43	AK18	AK26	1.54	AK81	AK124	1.67	AK39	AK64	1.81	AK23	AK44	1.97	AK15	AK30
1.43	AK94	AK134	1.55	AK16	AK25	1.67	AK51	AK84	1.81	AK34	AK64	1.97	AK79	AK154
1.43	AK66	AK94	1.55	AK27	AK44	1.67	AK54	AK89	1.81	AK69	AK124	1.97	AK16	AK32
1.43	AK34	AK51	1.55	AK71	AK109	1.67	AK66	AK109	1.82	AK24	AK46	1.97	AK51	AK99
1.43	AK59	AK84	1.55	AK25	AK41	1.67	AK69	AK114	1.82	AK35	AK66	1.97	AK17	AK34
1.44	AK27	AK41	1.55	AK74	AK114	1.67	AK81	AK134	1.82	AK19	AK35	1.97	AK56	AK109
1.44	AK22	AK32	1.55	AK61	AK94	1.67	AK49	AK81	1.82	AK44	AK79	1.97	AK94	AK184
1.44	AK69	AK99	1.56	AK59	AK91	1.68	AK35	AK61	1.83	AK74	AK134	1.98	AK21	AK44
1.45	AK24	AK35	1.56	AK30	AK49	1.68	AK32	AK56	1.83	AK20	AK39	1.98	AK22	AK46
1.45	AK46	AK66	1.56	AK64	AK99	1.68	AK26	AK46	1.83	AK32	AK61	1.98	AK26	AK54
1.45	AK15	AK22	1.56	AK28	AK46	1.68	AK23	AK41	1.84	AK41	AK74	1.98	AK27	AK56
1.45	AK79	AK114	1.56	AK46	AK71	1.68	AK20	AK34	1.84	AK21	AK41	1.98	AK32	AK66
1.45	AK39	AK56	1.56	AK19	AK30	1.69	AK74	AK124	1.84	AK15	AK28	2.01	AK46	AK91
1.46	AK41	AK59	1.57	AK51	AK79	1.70	AK59	AK99	1.84	AK79	AK144	2.01	AK41	AK81
1.46	AK17	AK25	1.57	AK17	AK27	1.70	AK56	AK94	1.84	AK28	AK54	2.01	AK34	AK71
1.46	AK56	AK81	1.57	AK54	AK84	1.70	AK91	AK154	1.84	AK49	AK89	2.02	AK28	AK59
1.46	AK30	AK46	1.58	AK22	AK35	1.70	AK54	AK91	1.85	AK16	AK30	2.02	AK24	AK51
1.46	AK19	AK28	1.58	AK34	AK56	1.71	AK44	AK74	1.85	AK84	AK154	2.02	AK23	AK49
1.46	AK32	AK49	1.58	AK15	AK24	1.71	AK41	AK69	1.85	AK39	AK71	2.03	AK19	AK41
1.46	AK49	AK71	1.58	AK79	AK124	1.71	AK79	AK134	1.85	AK46	AK84	2.03	AK18	AK39
1.46	AK51	AK74	1.58	AK41	AK64	1.71	AK15	AK26	1.86	AK17	AK32	2.03	AK17	AK35
1.47	AK23	AK34	1.59	AK20	AK32	1.72	AK39	AK66	1.86	AK54	AK99	2.04	AK91	AK184
1.47	AK25	AK39	1.59	AK39	AK61	1.72	AK64	AK109	1.86	AK25	AK49	2.04	AK35	AK74
1.47	AK44	AK64	1.59	AK44	AK69	1.72	AK30	AK54	1.86	AK18	AK34	2.05	AK54	AK109
1.47	AK61	AK89	1.59	AK66	AK104	1.72	AK61	AK104	1.87	AK26	AK51	2.05	AK30	AK64
1.47	AK71	AK104	1.59	AK91	AK144	1.72	AK34	AK61	1.87	AK51	AK94	2.05	AK71	AK144
1.48	AK54	AK79	1.59	AK69	AK109	1.73	AK16	AK28	1.87	AK34	AK66	2.05	AK49	AK99
1.48	AK35	AK54	1.60	AK23	AK39	1.73	AK27	AK49	1.87	AK59	AK109	2.05	AK66	AK134
1.48	AK64	AK94	1.60	AK26	AK44	1.73	AK84	AK144	1.87	AK44	AK81	2.06	AK26	AK56
1.48	AK91	AK134	1.60	AK21	AK34	1.73	AK20	AK35	1.88	AK56	AK104	2.06	AK25	AK54
1.48	AK74	AK109	1.61	AK56	AK89	1.73	AK24	AK44	1.88	AK49	AK91	2.06	AK44	AK89
1.48	AK16	AK24	1.61	AK16	AK26	1.74	AK28	AK51	1.89	AK30	AK59	2.06	AK61	AK124
1.48	AK84	AK124	1.61	AK51	AK81	1.74	AK49	AK84	1.89	AK22	AK44	2.06	AK56	AK114
1.49	AK18	AK27	1.61	AK84	AK134	1.74	AK46	AK79	1.89	AK61	AK114	2.07	AK39	AK79
1.49	AK20	AK30	1.61	AK59	AK94	1.74	AK17	AK30	1.89	AK23	AK46	2.07	AK21	AK46
1.49	AK26	AK41	1.61	AK24	AK41	1.74	AK89	AK154	1.90	AK66	AK124	2.07	AK51	AK104
1.49	AK28	AK44	1.62	AK32	AK54	1.74	AK21	AK39	1.90	AK35	AK69	2.07	AK20	AK44
1.50	AK61	AK91	1.62	AK27	AK46	1.74	AK66	AK114	1.91	AK71	AK134	2.08	AK32	AK69
1.51	AK41	AK61	1.62	AK71	AK114	1.75	AK25	AK46	1.91	AK27	AK54	2.08	AK46	AK94
1.51	AK23	AK35	1.62	AK35	AK59	1.76	AK22	AK41	1.91	AK28	AK56	2.09	AK89	AK184
1.51	AK21	AK32	1.62	AK30	AK51	1.76	AK18	AK32	1.92	AK81	AK154	2.09	AK28	AK61
1.51	AK66	AK99	1.63	AK17	AK28	1.76	AK41	AK71	1.92	AK18	AK35	2.09	AK41	AK84
1.51	AK56	AK84	1.63	AK89	AK144	1.76	AK35	AK64	1.92	AK19	AK39	2.09	AK27	AK59

Drive Ratios Using 4L, AP & AX Belts In AK Sheaves

Ratio	DR	DN	Ratio	DR	DN	Ratio	DR	DN	Ratio	DR	DN	Ratio	DR	DN
2.09	AK16	AK34	2.30	AK81	AK184	2.54	AK19	AK51	2.83	AK34	AK99	3.15	AK20	AK66
2.10	AK15	AK32	2.30	AK18	AK44	2.54	AK32	AK84	2.83	AK17	AK51	3.15	AK32	AK104
2.10	AK34	AK74	2.30	AK21	AK51	2.54	AK30	AK79	2.83	AK66	AK184	3.16	AK24	AK79
2.10	AK74	AK154	2.30	AK46	AK104	2.54	AK17	AK46	2.84	AK24	AK71	3.17	AK35	AK114
2.11	AK44	AK91	2.30	AK34	AK81	2.54	AK28	AK74	2.84	AK18	AK54	3.17	AK59	AK184
2.11	AK23	AK51	2.30	AK59	AK134	2.55	AK26	AK69	2.84	AK25	AK74	3.18	AK16	AK54
2.11	AK22	AK49	2.32	AK20	AK49	2.55	AK15	AK41	2.85	AK32	AK94	3.18	AK27	AK89
2.11	AK69	AK144	2.32	AK23	AK56	2.55	AK24	AK64	2.85	AK41	AK114	3.19	AK15	AK51
2.11	AK30	AK66	2.32	AK35	AK84	2.56	AK22	AK59	2.87	AK22	AK66	3.20	AK30	AK99
2.12	AK39	AK81	2.33	AK22	AK54	2.56	AK20	AK54	2.87	AK39	AK109	3.20	AK46	AK144
2.12	AK64	AK134	2.33	AK25	AK61	2.56	AK61	AK154	2.87	AK30	AK89	3.21	AK19	AK64
2.13	AK59	AK124	2.33	AK39	AK89	2.57	AK18	AK49	2.87	AK15	AK46	3.21	AK49	AK154
2.14	AK18	AK41	2.33	AK54	AK124	2.58	AK16	AK44	2.87	AK23	AK69	3.22	AK18	AK61
2.14	AK25	AK56	2.34	AK41	AK94	2.58	AK49	AK124	2.88	AK16	AK49	3.22	AK22	AK74
2.14	AK32	AK71	2.35	AK27	AK66	2.59	AK34	AK91	2.88	AK51	AK144	3.23	AK21	AK71
2.14	AK17	AK39	2.35	AK24	AK59	2.59	AK41	AK104	2.88	AK44	AK124	3.24	AK25	AK84
2.14	AK24	AK54	2.35	AK79	AK184	2.60	AK39	AK99	2.89	AK35	AK104	3.24	AK24	AK81
2.14	AK54	AK114	2.36	AK26	AK64	2.61	AK35	AK94	2.89	AK27	AK81	3.25	AK28	AK94
2.15	AK16	AK35	2.36	AK66	AK154	2.61	AK30	AK81	2.89	AK28	AK84	3.25	AK27	AK91
2.16	AK49	AK104	2.37	AK28	AK69	2.61	AK56	AK144	2.90	AK20	AK61	3.26	AK34	AK114
2.16	AK27	AK61	2.37	AK49	AK114	2.62	AK26	AK71	2.90	AK54	AK154	3.27	AK39	AK124
2.17	AK26	AK59	2.38	AK30	AK74	2.63	AK71	AK184	2.91	AK21	AK64	3.29	AK17	AK59
2.17	AK20	AK46	2.38	AK32	AK79	2.63	AK24	AK66	2.92	AK64	AK184	3.29	AK20	AK69
2.17	AK51	AK109	2.39	AK39	AK91	2.64	AK27	AK74	2.92	AK26	AK79	3.30	AK23	AK79
2.18	AK44	AK94	2.39	AK34	AK84	2.64	AK22	AK61	2.93	AK30	AK91	3.30	AK26	AK89
2.18	AK19	AK44	2.39	AK16	AK41	2.65	AK44	AK114	2.95	AK18	AK56	3.30	AK16	AK56
2.18	AK35	AK79	2.39	AK61	AK144	2.65	AK25	AK69	2.95	AK19	AK59	3.31	AK19	AK66
2.19	AK46	AK99	2.41	AK18	AK46	2.65	AK59	AK154	2.96	AK23	AK71	3.31	AK32	AK109
2.19	AK28	AK64	2.41	AK44	AK104	2.66	AK20	AK56	2.96	AK24	AK74	3.35	AK56	AK184
2.19	AK71	AK154	2.41	AK20	AK51	2.66	AK23	AK64	2.97	AK34	AK104	3.35	AK44	AK144
2.20	AK22	AK51	2.42	AK46	AK109	2.67	AK21	AK59	2.98	AK46	AK134	3.35	AK41	AK134
2.20	AK39	AK84	2.42	AK15	AK39	2.68	AK18	AK51	3.00	AK21	AK66	3.36	AK30	AK104
2.21	AK21	AK49	2.42	AK22	AK56	2.68	AK51	AK134	3.00	AK26	AK81	3.36	AK27	AK94
2.21	AK66	AK144	2.43	AK24	AK61	2.68	AK34	AK94	3.00	AK16	AK51	3.37	AK24	AK84
2.21	AK84	AK184	2.43	AK17	AK44	2.69	AK19	AK54	3.00	AK17	AK54	3.37	AK21	AK74
2.21	AK30	AK69	2.43	AK56	AK134	2.69	AK32	AK89	3.00	AK22	AK69	3.38	AK26	AK91
2.22	AK41	AK89	2.43	AK26	AK66	2.70	AK16	AK46	3.00	AK27	AK84	3.38	AK18	AK64
2.22	AK24	AK56	2.44	AK19	AK49	2.70	AK69	AK184	3.00	AK32	AK99	3.38	AK23	AK81
2.23	AK15	AK34	2.44	AK28	AK71	2.70	AK30	AK84	3.00	AK39	AK114	3.39	AK15	AK54
2.23	AK61	AK134	2.44	AK64	AK154	2.71	AK17	AK49	3.00	AK49	AK144	3.39	AK20	AK71
2.23	AK32	AK74	2.44	AK21	AK54	2.71	AK54	AK144	3.03	AK35	AK109	3.40	AK17	AK61
2.23	AK23	AK54	2.45	AK32	AK81	2.72	AK28	AK79	3.03	AK30	AK94	3.42	AK28	AK99
2.24	AK35	AK81	2.45	AK23	AK59	2.72	AK41	AK109	3.04	AK25	AK79	3.43	AK46	AK154
2.25	AK26	AK61	2.45	AK25	AK64	2.73	AK25	AK71	3.05	AK20	AK64	3.43	AK25	AK89
2.25	AK34	AK79	2.45	AK27	AK69	2.73	AK39	AK104	3.05	AK19	AK61	3.44	AK22	AK79
2.25	AK56	AK124	2.46	AK35	AK89	2.74	AK26	AK74	3.06	AK15	AK49	3.45	AK35	AK124
2.25	AK25	AK59	2.47	AK39	AK94	2.74	AK15	AK44	3.07	AK61	AK184	3.46	AK19	AK69
2.26	AK17	AK41	2.47	AK41	AK99	2.74	AK23	AK66	3.07	AK28	AK89	3.46	AK32	AK114
2.26	AK69	AK154	2.47	AK51	AK124	2.75	AK35	AK99	3.08	AK51	AK154	3.48	AK54	AK184
2.26	AK28	AK66	2.48	AK59	AK144	2.75	AK46	AK124	3.09	AK23	AK74	3.48	AK16	AK59
2.26	AK49	AK109	2.52	AK74	AK184	2.75	AK32	AK91	3.09	AK22	AK71	3.49	AK18	AK66
2.27	AK41	AK91	2.52	AK35	AK91	2.76	AK24	AK69	3.10	AK41	AK124	3.49	AK26	AK94
2.27	AK16	AK39	2.52	AK54	AK134	2.77	AK21	AK61	3.11	AK18	AK59	3.51	AK25	AK91
2.27	AK27	AK64	2.53	AK27	AK71	2.78	AK22	AK64	3.11	AK26	AK84	3.51	AK23	AK84
2.27	AK51	AK114	2.53	AK46	AK114	2.79	AK28	AK81	3.11	AK17	AK56	3.52	AK15	AK56
2.28	AK30	AK71	2.53	AK25	AK66	2.79	AK49	AK134	3.12	AK34	AK109	3.52	AK30	AK109
2.28	AK64	AK144	2.53	AK44	AK109	2.79	AK19	AK56	3.12	AK25	AK81	3.53	AK22	AK81
2.28	AK19	AK46	2.53	AK23	AK61	2.80	AK56	AK154	3.12	AK44	AK134	3.53	AK39	AK134
2.29	AK15	AK35	2.53	AK21	AK56	2.80	AK20	AK59	3.14	AK21	AK69	3.54	AK20	AK74
2.29	AK44	AK99	2.54	AK34	AK89	2.82	AK27	AK79	3.14	AK28	AK91	3.55	AK27	AK99

Drive Ratios Using 4L, AP & AX Belts In AK Sheaves

Ratio	DR	DN	Ratio	DR	DN	Ratio	DR	DN	Ratio	DR	DN	Ratio	DR	DN
3.55	AK34	AK124	3.97	AK19	AK79	4.48	AK15	AK71	5.24	AK20	AK109	6.49	AK23	AK154
3.56	AK19	AK71	3.98	AK22	AK91	4.49	AK19	AK89	5.26	AK19	AK104	6.52	AK16	AK109
3.57	AK17	AK64	3.98	AK24	AK99	4.51	AK20	AK94	5.27	AK18	AK99	6.61	AK15	AK104
3.57	AK24	AK89	4.01	AK35	AK144	4.53	AK21	AK99	5.29	AK17	AK94	6.62	AK18	AK124
3.59	AK44	AK154	4.02	AK30	AK124	4.54	AK17	AK81	5.29	AK34	AK184	6.63	AK21	AK144
3.60	AK28	AK104	4.02	AK25	AK104	4.56	AK22	AK104	5.30	AK16	AK89	6.64	AK27	AK184
3.60	AK21	AK79	4.02	AK20	AK84	4.57	AK23	AK109	5.32	AK15	AK84	6.78	AK22	AK154
3.61	AK16	AK61	4.03	AK15	AK64	4.59	AK19	AK91	5.35	AK28	AK154	6.79	AK19	AK134
3.61	AK41	AK144	4.06	AK26	AK109	4.59	AK24	AK114	5.38	AK26	AK144	6.82	AK16	AK114
3.63	AK25	AK94	4.07	AK39	AK154	4.62	AK41	AK184	5.41	AK24	AK134	6.89	AK26	AK184
3.65	AK18	AK69	4.07	AK21	AK89	4.62	AK26	AK124	5.42	AK16	AK91	6.94	AK15	AK109
3.65	AK24	AK91	4.08	AK19	AK81	4.65	AK28	AK134	5.44	AK22	AK124	6.95	AK20	AK144
3.67	AK22	AK84	4.08	AK32	AK134	4.67	AK30	AK144	5.49	AK20	AK114	7.00	AK17	AK124
3.68	AK26	AK99	4.09	AK16	AK69	4.68	AK15	AK74	5.51	AK19	AK109	7.09	AK21	AK154
3.69	AK17	AK66	4.09	AK27	AK114	4.69	AK32	AK154	5.54	AK18	AK104	7.16	AK25	AK184
3.69	AK51	AK184	4.10	AK46	AK184	4.70	AK16	AK79	5.55	AK27	AK154	7.16	AK18	AK134
3.69	AK30	AK114	4.11	AK22	AK94	4.71	AK17	AK84	5.57	AK17	AK99	7.26	AK15	AK114
3.70	AK21	AK81	4.13	AK34	AK144	4.73	AK18	AK89	5.59	AK25	AK144	7.31	AK19	AK144
3.71	AK15	AK59	4.14	AK17	AK74	4.74	AK19	AK94	5.61	AK16	AK94	7.42	AK16	AK124
3.72	AK19	AK74	4.15	AK23	AK99	4.76	AK20	AK99	5.62	AK32	AK184	7.44	AK20	AK154
3.72	AK23	AK89	4.16	AK15	AK66	4.77	AK21	AK104	5.64	AK23	AK134	7.45	AK24	AK184
3.73	AK27	AK104	4.16	AK21	AK91	4.78	AK22	AK109	5.65	AK15	AK89	7.57	AK17	AK134
3.73	AK35	AK134	4.18	AK24	AK104	4.79	AK23	AK114	5.70	AK21	AK124	7.70	AK18	AK144
3.76	AK18	AK71	4.19	AK18	AK79	4.80	AK25	AK124	5.75	AK26	AK154	7.77	AK23	AK184
3.77	AK32	AK124	4.21	AK16	AK71	4.82	AK16	AK81	5.77	AK19	AK114	7.82	AK19	AK154
3.77	AK28	AK109	4.22	AK25	AK109	4.82	AK27	AK134	5.77	AK15	AK91	7.90	AK15	AK124
3.78	AK24	AK94	4.23	AK19	AK84	4.84	AK18	AK91	5.81	AK18	AK109	8.03	AK16	AK134
3.78	AK20	AK79	4.25	AK26	AK114	4.87	AK39	AK184	5.82	AK24	AK144	8.11	AK22	AK184
3.79	AK16	AK64	4.27	AK20	AK89	5.00	AK15	AK79	5.86	AK17	AK104	8.14	AK17	AK144
3.80	AK39	AK144	4.29	AK44	AK184	5.00	AK16	AK84	5.89	AK22	AK134	8.24	AK18	AK154
3.81	AK23	AK91	4.30	AK35	AK154	5.00	AK17	AK89	5.91	AK16	AK99	8.49	AK21	AK184
3.82	AK25	AK99	4.30	AK18	AK81	5.00	AK18	AK94	5.97	AK15	AK94	8.55	AK15	AK134
3.84	AK21	AK84	4.30	AK28	AK124	5.00	AK19	AK99	5.98	AK20	AK124	8.64	AK16	AK144
3.84	AK15	AK61	4.30	AK21	AK94	5.00	AK20	AK104	5.98	AK25	AK154	8.71	AK17	AK154
3.84	AK34	AK134	4.33	AK22	AK99	5.00	AK21	AK109	5.98	AK30	AK184	8.90	AK20	AK184
3.84	AK49	AK184	4.34	AK30	AK134	5.00	AK22	AK114	6.06	AK23	AK144	9.19	AK15	AK144
3.86	AK17	AK69	4.35	AK15	AK69	5.00	AK24	AK124	6.08	AK18	AK114	9.24	AK16	AK154
3.86	AK41	AK154	4.36	AK23	AK104	5.00	AK26	AK134	6.14	AK17	AK109	9.36	AK19	AK184
3.87	AK26	AK104	4.37	AK20	AK91	5.00	AK28	AK144	6.16	AK21	AK134	9.84	AK15	AK154
3.88	AK20	AK81	4.38	AK32	AK144	5.00	AK30	AK154	6.21	AK16	AK104	9.86	AK18	AK184
3.89	AK22	AK89	4.39	AK24	AK109	5.11	AK17	AK91	6.22	AK24	AK154	10.43	AK17	AK184
3.91	AK16	AK66	4.39	AK16	AK74	5.13	AK15	AK81	6.28	AK19	AK124	11.06	AK16	AK184
3.91	AK27	AK109	4.41	AK25	AK114	5.14	AK35	AK184	6.29	AK15	AK99	11.77	AK15	AK184
3.92	AK18	AK74	4.42	AK34	AK154	5.18	AK27	AK144	6.33	AK22	AK144			
3.94	AK23	AK94	4.43	AK17	AK79	5.20	AK25	AK134	6.40	AK28	AK184			
3.95	AK28	AK114	4.45	AK27	AK124	5.21	AK23	AK124	6.43	AK17	AK114			
3.97	AK17	AK71	4.46	AK18	AK84	5.23	AK21	AK114	6.46	AK20	AK134			

Drive Ratios Using 4L, AP & AX Belts In BK Sheaves

Ratio	DR	DN	Ratio	DR	DN	Ratio	DR	DN	Ratio	DR	DN	Ratio	DR	DN
1.00	BK24	BK24	1.07	BK32	BK34	1.18	BK90	BK105	1.30	BK90	BK115	1.44	BK75	BK105
1.00	BK25	BK25	1.07	BK75	BK80	1.18	BK62	BK72	1.30	BK57	BK72	1.45	BK52	BK72
1.00	BK26	BK26	1.08	BK30	BK32	1.18	BK36	BK46	1.31	BK36	BK50	1.45	BK85	BK120
1.00	BK27	BK27	1.08	BK47	BK50	1.19	BK45	BK52	1.32	BK32	BK45	1.45	BK30	BK46
1.00	BK28	BK28	1.08	BK72	BK77	1.19	BK77	BK90	1.32	BK55	BK70	1.45	BK45	BK62
1.00	BK30	BK30	1.08	BK45	BK48	1.19	BK60	BK70	1.32	BK45	BK57	1.46	BK47	BK65
1.00	BK32	BK32	1.08	BK70	BK75	1.19	BK85	BK100	1.32	BK70	BK90	1.46	BK34	BK52
1.00	BK34	BK34	1.08	BK28	BK30	1.20	BK24	BK28	1.32	BK85	BK110	1.46	BK36	BK55
1.00	BK36	BK36	1.08	BK67	BK72	1.20	BK72	BK85	1.32	BK60	BK77	1.46	BK55	BK77
1.00	BK40	BK40	1.09	BK40	BK45	1.20	BK57	BK67	1.32	BK100	BK130	1.46	BK57	BK80
1.00	BK45	BK45	1.09	BK65	BK70	1.20	BK47	BK55	1.33	BK25	BK32	1.47	BK27	BK40
1.00	BK46	BK46	1.09	BK26	BK28	1.21	BK80	BK95	1.33	BK28	BK36	1.47	BK48	BK67
1.00	BK47	BK47	1.09	BK62	BK67	1.21	BK65	BK77	1.33	BK34	BK48	1.47	BK50	BK70
1.00	BK48	BK48	1.09	BK25	BK27	1.21	BK32	BK40	1.33	BK47	BK60	1.47	BK67	BK95
1.00	BK50	BK50	1.10	BK60	BK65	1.21	BK55	BK65	1.33	BK62	BK80	1.47	BK77	BK110
1.00	BK52	BK52	1.10	BK24	BK26	1.21	BK27	BK32	1.33	BK77	BK100	1.48	BK60	BK85
1.00	BK55	BK55	1.10	BK48	BK52	1.22	BK36	BK47	1.34	BK52	BK67	1.48	BK70	BK100
1.00	BK57	BK57	1.10	BK57	BK62	1.22	BK100	BK120	1.34	BK80	BK105	1.48	BK80	BK115
1.00	BK60	BK60	1.10	BK46	BK50	1.22	BK67	BK80	1.35	BK48	BK62	1.48	BK90	BK130
1.00	BK62	BK62	1.11	BK55	BK60	1.22	BK48	BK57	1.35	BK65	BK85	1.49	BK24	BK34
1.00	BK65	BK65	1.11	BK100	BK110	1.22	BK75	BK90	1.35	BK32	BK46	1.49	BK30	BK47
1.00	BK67	BK67	1.11	BK70	BK77	1.22	BK52	BK62	1.35	BK50	BK65	1.49	BK32	BK50
1.00	BK70	BK70	1.11	BK52	BK57	1.23	BK30	BK36	1.36	BK26	BK34	1.49	BK46	BK65
1.00	BK72	BK72	1.11	BK95	BK105	1.23	BK60	BK72	1.36	BK72	BK95	1.51	BK47	BK67
1.00	BK75	BK75	1.12	BK77	BK85	1.23	BK95	BK115	1.36	BK55	BK72	1.51	BK25	BK36
1.00	BK77	BK77	1.12	BK40	BK46	1.23	BK34	BK45	1.36	BK46	BK60	1.51	BK72	BK105
1.00	BK80	BK80	1.12	BK50	BK55	1.23	BK40	BK50	1.36	BK57	BK75	1.51	BK62	BK90
1.00	BK85	BK85	1.12	BK90	BK100	1.23	BK25	BK30	1.36	BK90	BK120	1.51	BK95	BK140
1.00	BK90	BK90	1.12	BK65	BK72	1.23	BK46	BK55	1.37	BK36	BK52	1.52	BK52	BK75
1.00	BK95	BK95	1.12	BK72	BK80	1.24	BK50	BK60	1.37	BK75	BK100	1.52	BK50	BK72
1.00	BK100	BK100	1.13	BK47	BK52	1.24	BK62	BK75	1.38	BK40	BK55	1.52	BK75	BK110
1.03	BK47	BK48	1.13	BK27	BK30	1.24	BK70	BK85	1.38	BK47	BK62	1.52	BK40	BK60
1.03	BK46	BK47	1.13	BK85	BK95	1.24	BK90	BK110	1.38	BK60	BK80	1.52	BK65	BK95
1.03	BK45	BK46	1.13	BK34	BK40	1.24	BK28	BK34	1.38	BK27	BK36	1.52	BK36	BK57
1.03	BK75	BK77	1.13	BK45	BK50	1.25	BK36	BK48	1.39	BK32	BK47	1.53	BK55	BK80
1.03	BK70	BK72	1.13	BK60	BK67	1.25	BK55	BK67	1.39	BK67	BK90	1.53	BK30	BK48
1.03	BK65	BK67	1.13	BK67	BK75	1.25	BK47	BK57	1.39	BK85	BK115	1.53	BK28	BK45
1.04	BK60	BK62	1.14	BK80	BK90	1.26	BK85	BK105	1.39	BK24	BK32	1.53	BK26	BK40
1.04	BK55	BK57	1.14	BK25	BK28	1.26	BK77	BK95	1.39	BK34	BK50	1.53	BK45	BK65
1.04	BK27	BK28	1.14	BK32	BK36	1.26	BK65	BK80	1.40	BK45	BK60	1.54	BK48	BK70
1.04	BK77	BK80	1.14	BK40	BK47	1.26	BK34	BK46	1.40	BK50	BK67	1.55	BK46	BK67
1.04	BK26	BK27	1.15	BK24	BK27	1.26	BK57	BK70	1.40	BK70	BK95	1.55	BK77	BK115
1.05	BK25	BK26	1.15	BK62	BK70	1.27	BK26	BK32	1.40	BK95	BK130	1.55	BK80	BK120
1.05	BK72	BK75	1.15	BK55	BK62	1.27	BK45	BK55	1.40	BK77	BK105	1.55	BK67	BK100
1.05	BK50	BK52	1.15	BK75	BK85	1.28	BK62	BK77	1.40	BK57	BK77	1.56	BK34	BK55
1.05	BK24	BK25	1.15	BK30	BK34	1.28	BK80	BK100	1.40	BK52	BK70	1.56	BK70	BK105
1.05	BK48	BK50	1.15	BK36	BK45	1.28	BK72	BK90	1.41	BK28	BK40	1.56	BK32	BK52
1.05	BK67	BK70	1.16	BK46	BK52	1.28	BK50	BK62	1.41	BK80	BK110	1.56	BK52	BK77
1.05	BK46	BK48	1.16	BK70	BK80	1.29	BK46	BK57	1.42	BK30	BK45	1.57	BK57	BK85
1.05	BK45	BK47	1.16	BK57	BK65	1.29	BK60	BK75	1.42	BK46	BK62	1.57	BK28	BK46
1.05	BK100	BK105	1.16	BK100	BK115	1.29	BK95	BK120	1.42	BK25	BK34	1.57	BK60	BK90
1.06	BK62	BK65	1.16	BK28	BK32	1.29	BK40	BK52	1.42	BK48	BK65	1.58	BK40	BK62
1.06	BK95	BK100	1.16	BK50	BK57	1.29	BK52	BK65	1.42	BK55	BK75	1.58	BK85	BK130
1.06	BK90	BK95	1.17	BK67	BK77	1.29	BK24	BK30	1.42	BK32	BK48	1.58	BK47	BK70
1.06	BK57	BK60	1.17	BK95	BK110	1.30	BK34	BK47	1.42	BK62	BK85	1.59	BK24	BK36
1.06	BK36	BK40	1.17	BK48	BK55	1.30	BK48	BK60	1.43	BK100	BK140	1.59	BK45	BK67
1.06	BK85	BK90	1.17	BK65	BK75	1.30	BK75	BK95	1.43	BK72	BK100	1.59	BK50	BK75
1.07	BK34	BK36	1.17	BK40	BK48	1.30	BK27	BK34	1.43	BK40	BK57	1.59	BK72	BK110
1.07	BK52	BK55	1.18	BK26	BK30	1.30	BK30	BK40	1.43	BK65	BK90	1.59	BK48	BK72
1.07	BK80	BK85	1.18	BK52	BK60	1.30	BK67	BK85	1.44	BK26	BK36	1.59	BK75	BK115

Drive Ratios Using 4L, AP & AX Belts In BK Sheaves

Ratio	DR	DN	Ratio	DR	DN	Ratio	DR	DN	Ratio	DR	DN	Ratio	DR	DN
1.60	BK27	BK45	1.77	BK57	BK95	1.97	BK57	BK105	2.23	BK27	BK60	2.56	BK26	BK65
1.60	BK30	BK50	1.77	BK36	BK65	1.97	BK62	BK115	2.25	BK30	BK67	2.56	BK24	BK60
1.60	BK25	BK40	1.78	BK65	BK110	1.97	BK100	BK190	2.25	BK40	BK85	2.56	BK67	BK160
1.61	BK62	BK95	1.79	BK34	BK62	1.98	BK24	BK48	2.25	BK62	BK130	2.58	BK55	BK130
1.61	BK90	BK140	1.79	BK62	BK105	1.98	BK25	BK50	2.26	BK75	BK160	2.59	BK47	BK110
1.61	BK65	BK100	1.79	BK48	BK80	1.98	BK26	BK52	2.26	BK32	BK72	2.60	BK45	BK105
1.61	BK28	BK47	1.79	BK25	BK46	1.98	BK30	BK60	2.26	BK55	BK115	2.62	BK30	BK77
1.62	BK36	BK60	1.79	BK30	BK55	1.98	BK36	BK72	2.27	BK46	BK95	2.63	BK77	BK190
1.62	BK77	BK120	1.80	BK26	BK48	2.01	BK46	BK85	2.27	BK57	BK120	2.63	BK28	BK72
1.62	BK34	BK57	1.80	BK45	BK75	2.01	BK40	BK77	2.28	BK34	BK77	2.64	BK26	BK67
1.62	BK46	BK70	1.80	BK70	BK120	2.02	BK32	BK65	2.28	BK48	BK100	2.65	BK50	BK120
1.63	BK52	BK80	1.81	BK46	BK77	2.02	BK28	BK57	2.29	BK50	BK105	2.65	BK65	BK160
1.63	BK55	BK85	1.81	BK67	BK115	2.02	BK27	BK55	2.30	BK25	BK57	2.65	BK48	BK115
1.63	BK47	BK72	1.81	BK27	BK50	2.04	BK48	BK90	2.30	BK52	BK110	2.66	BK24	BK62
1.64	BK50	BK77	1.81	BK40	BK70	2.05	BK60	BK115	2.30	BK65	BK140	2.66	BK27	BK70
1.64	BK27	BK46	1.81	BK75	BK130	2.05	BK34	BK70	2.32	BK24	BK55	2.66	BK46	BK110
1.64	BK67	BK105	1.82	BK28	BK52	2.05	BK55	BK105	2.32	BK27	BK62	2.67	BK25	BK65
1.64	BK70	BK110	1.82	BK50	BK85	2.05	BK72	BK140	2.33	BK26	BK60	2.68	BK57	BK140
1.65	BK100	BK160	1.83	BK80	BK140	2.06	BK30	BK62	2.33	BK45	BK95	2.68	BK40	BK100
1.65	BK28	BK48	1.83	BK24	BK45	2.06	BK50	BK95	2.33	BK60	BK130	2.69	BK36	BK95
1.67	BK26	BK45	1.83	BK36	BK67	2.06	BK67	BK130	2.34	BK47	BK100	2.70	BK75	BK190
1.67	BK32	BK55	1.84	BK47	BK80	2.06	BK62	BK120	2.35	BK28	BK65	2.70	BK34	BK90
1.67	BK40	BK65	1.84	BK25	BK47	2.07	BK45	BK85	2.35	BK85	BK190	2.72	BK32	BK85
1.67	BK45	BK70	1.84	BK32	BK60	2.07	BK25	BK52	2.36	BK30	BK70	2.72	BK47	BK115
1.67	BK48	BK75	1.84	BK55	BK95	2.07	BK57	BK110	2.36	BK72	BK160	2.73	BK45	BK110
1.67	BK57	BK90	1.85	BK90	BK160	2.07	BK24	BK50	2.37	BK32	BK75	2.74	BK30	BK80
1.67	BK60	BK95	1.85	BK45	BK77	2.08	BK36	BK75	2.37	BK55	BK120	2.74	BK27	BK72
1.67	BK72	BK115	1.85	BK52	BK90	2.08	BK52	BK100	2.38	BK34	BK80	2.75	BK52	BK130
1.67	BK75	BK120	1.86	BK60	BK105	2.09	BK95	BK190	2.38	BK36	BK85	2.76	BK28	BK75
1.68	BK46	BK72	1.87	BK30	BK57	2.09	BK32	BK67	2.39	BK40	BK90	2.77	BK25	BK67
1.68	BK36	BK62	1.87	BK57	BK100	2.09	BK47	BK90	2.40	BK46	BK100	2.78	BK26	BK70
1.68	BK30	BK52	1.87	BK40	BK72	2.10	BK40	BK80	2.41	BK48	BK105	2.78	BK48	BK120
1.68	BK27	BK47	1.87	BK65	BK115	2.10	BK80	BK160	2.41	BK50	BK110	2.79	BK55	BK140
1.68	BK24	BK40	1.88	BK24	BK46	2.11	BK27	BK57	2.41	BK24	BK57	2.79	BK46	BK115
1.69	BK80	BK130	1.88	BK62	BK110	2.11	BK26	BK55	2.42	BK52	BK115	2.80	BK62	BK160
1.70	BK65	BK105	1.88	BK46	BK80	2.11	BK34	BK72	2.42	BK26	BK62	2.80	BK24	BK65
1.70	BK62	BK100	1.88	BK25	BK48	2.12	BK70	BK140	2.43	BK28	BK67	2.83	BK40	BK105
1.71	BK50	BK80	1.89	BK34	BK65	2.13	BK65	BK130	2.43	BK62	BK140	2.83	BK72	BK190
1.71	BK47	BK75	1.89	BK26	BK50	2.14	BK36	BK77	2.43	BK30	BK72	2.84	BK28	BK77
1.71	BK85	BK140	1.89	BK67	BK120	2.14	BK28	BK60	2.44	BK32	BK77	2.85	BK36	BK100
1.71	BK26	BK46	1.89	BK27	BK52	2.14	BK60	BK120	2.44	BK70	BK160	2.85	BK47	BK120
1.72	BK48	BK77	1.90	BK72	BK130	2.14	BK46	BK90	2.44	BK25	BK60	2.87	BK26	BK72
1.72	BK45	BK72	1.91	BK77	BK140	2.16	BK55	BK110	2.45	BK27	BK65	2.87	BK45	BK115
1.72	BK70	BK115	1.91	BK32	BK62	2.16	BK48	BK95	2.47	BK45	BK100	2.87	BK34	BK95
1.72	BK34	BK60	1.91	BK48	BK85	2.17	BK30	BK65	2.47	BK47	BK105	2.87	BK27	BK75
1.72	BK67	BK110	1.92	BK36	BK70	2.17	BK24	BK52	2.47	BK57	BK130	2.88	BK50	BK130
1.72	BK27	BK48	1.93	BK24	BK47	2.17	BK57	BK115	2.52	BK80	BK190	2.89	BK32	BK90
1.72	BK40	BK67	1.93	BK45	BK80	2.18	BK50	BK100	2.52	BK60	BK140	2.90	BK24	BK67
1.73	BK28	BK50	1.94	BK28	BK55	2.19	BK52	BK105	2.53	BK52	BK120	2.90	BK60	BK160
1.74	BK32	BK57	1.94	BK50	BK90	2.19	BK32	BK70	2.53	BK50	BK115	2.91	BK25	BK70
1.74	BK55	BK90	1.95	BK55	BK100	2.19	BK77	BK160	2.53	BK48	BK110	2.92	BK70	BK190
1.74	BK52	BK85	1.95	BK34	BK67	2.20	BK26	BK57	2.53	BK27	BK67	2.92	BK46	BK120
1.74	BK95	BK160	1.95	BK60	BK110	2.20	BK45	BK90	2.53	BK46	BK105	2.92	BK30	BK85
1.74	BK25	BK45	1.96	BK40	BK75	2.21	BK25	BK55	2.53	BK25	BK62	2.96	BK27	BK77
1.74	BK72	BK120	1.96	BK65	BK120	2.21	BK90	BK190	2.54	BK40	BK95	2.96	BK28	BK80
1.75	BK46	BK75	1.96	BK70	BK130	2.21	BK34	BK75	2.54	BK36	BK90	2.97	BK40	BK110
1.76	BK26	BK47	1.96	BK47	BK85	2.22	BK47	BK95	2.54	BK34	BK85	2.98	BK52	BK140
1.76	BK47	BK77	1.96	BK75	BK140	2.22	BK28	BK62	2.54	BK32	BK80	3.00	BK25	BK72
1.76	BK60	BK100	1.97	BK52	BK95	2.23	BK67	BK140	2.55	BK30	BK75	3.00	BK26	BK75
1.76	BK77	BK130	1.97	BK85	BK160	2.23	BK36	BK80	2.55	BK28	BK70	3.00	BK36	BK105

Drive Ratios Using 4L, AP & AX Belts In BK Sheaves

Ratio	DR	DN	Ratio	DR	DN	Ratio	DR	DN	Ratio	DR	DN	Ratio	DR	DN
3.00	BK45	BK120	3.30	BK30	BK95	3.77	BK48	BK160	4.30	BK25	BK100	5.23	BK25	BK120
3.02	BK48	BK130	3.31	BK36	BK115	3.77	BK36	BK130	4.33	BK26	BK105	5.24	BK24	BK115
3.03	BK34	BK100	3.35	BK62	BK190	3.77	BK32	BK115	4.34	BK34	BK140	5.29	BK40	BK190
3.05	BK24	BK70	3.35	BK47	BK140	3.78	BK28	BK100	4.36	BK27	BK110	5.35	BK32	BK160
3.07	BK67	BK190	3.36	BK34	BK110	3.78	BK24	BK85	4.39	BK28	BK115	5.41	BK28	BK140
3.07	BK32	BK95	3.37	BK28	BK90	3.84	BK25	BK90	4.42	BK40	BK160	5.44	BK26	BK130
3.08	BK57	BK160	3.37	BK25	BK80	3.84	BK40	BK140	4.51	BK48	BK190	5.49	BK24	BK120
3.09	BK27	BK80	3.39	BK24	BK77	3.84	BK55	BK190	4.51	BK24	BK100	5.62	BK36	BK190
3.09	BK26	BK77	3.42	BK32	BK105	3.86	BK47	BK160	4.53	BK25	BK105	5.64	BK27	BK140
3.10	BK47	BK130	3.43	BK52	BK160	3.87	BK30	BK110	4.56	BK26	BK110	5.70	BK25	BK130
3.11	BK30	BK90	3.44	BK46	BK140	3.89	BK26	BK95	4.57	BK27	BK115	5.75	BK30	BK160
3.12	BK40	BK115	3.44	BK26	BK85	3.94	BK27	BK100	4.59	BK28	BK120	5.89	BK26	BK140
3.12	BK50	BK140	3.46	BK36	BK120	3.95	BK32	BK120	4.62	BK47	BK190	5.98	BK24	BK130
3.14	BK25	BK75	3.48	BK60	BK190	3.96	BK46	BK160	4.62	BK30	BK130	5.98	BK34	BK190
3.15	BK24	BK72	3.49	BK30	BK100	3.98	BK28	BK105	4.65	BK32	BK140	6.16	BK25	BK140
3.15	BK36	BK110	3.51	BK27	BK90	4.02	BK34	BK130	4.69	BK36	BK160	6.22	BK28	BK160
3.16	BK28	BK85	3.52	BK34	BK115	4.02	BK24	BK90	4.74	BK46	BK190	6.40	BK32	BK190
3.17	BK65	BK190	3.53	BK45	BK140	4.06	BK30	BK115	4.76	BK24	BK105	6.46	BK24	BK140
3.18	BK46	BK130	3.54	BK24	BK80	4.07	BK45	BK160	4.77	BK25	BK110	6.49	BK27	BK160
3.20	BK34	BK105	3.55	BK40	BK130	4.07	BK25	BK95	4.78	BK26	BK115	6.78	BK26	BK160
3.21	BK55	BK160	3.57	BK28	BK95	4.08	BK36	BK140	4.79	BK27	BK120	6.89	BK30	BK190
3.22	BK26	BK80	3.59	BK50	BK160	4.10	BK52	BK190	4.87	BK45	BK190	7.09	BK25	BK160
3.23	BK25	BK77	3.60	BK32	BK110	4.11	BK26	BK100	5.00	BK24	BK110	7.44	BK24	BK160
3.25	BK32	BK100	3.60	BK25	BK85	4.15	BK27	BK105	5.00	BK25	BK115	7.45	BK28	BK190
3.26	BK40	BK120	3.67	BK26	BK90	4.18	BK28	BK110	5.00	BK26	BK120	7.77	BK27	BK190
3.27	BK45	BK130	3.68	BK30	BK105	4.25	BK30	BK120	5.00	BK28	BK130	8.11	BK26	BK190
3.27	BK48	BK140	3.69	BK57	BK190	4.27	BK24	BK95	5.00	BK30	BK140	8.49	BK25	BK190
3.29	BK24	BK75	3.69	BK34	BK120	4.29	BK50	BK190	5.00	BK34	BK160	8.90	BK24	BK190
3.30	BK27	BK85	3.72	BK27	BK95	4.30	BK32	BK130	5.21	BK27	BK130			

Drive Ratios Using 5L, BP & BX Belts In BK Sheaves

Ratio	DR	DN	Ratio	DR	DN	Ratio	DR	DN	Ratio	DR	DN	Ratio	DR	DN
1.00	BK19	BK19	1.05	BK105	BK110	1.13	BK36	BK45	1.22	BK70	BK85	1.32	BK80	BK105
1.00	BK22	BK22	1.05	BK62	BK65	1.13	BK55	BK62	1.22	BK115	BK140	1.32	BK32	BK47
1.00	BK23	BK23	1.05	BK100	BK105	1.13	BK115	BK130	1.22	BK34	BK46	1.32	BK40	BK55
1.00	BK24	BK24	1.05	BK36	BK40	1.13	BK28	BK32	1.22	BK47	BK57	1.33	BK57	BK75
1.00	BK25	BK25	1.05	BK95	BK100	1.13	BK62	BK70	1.23	BK55	BK67	1.33	BK72	BK95
1.00	BK26	BK26	1.05	BK57	BK60	1.14	BK46	BK52	1.23	BK90	BK110	1.33	BK19	BK26
1.00	BK27	BK27	1.06	BK34	BK36	1.14	BK75	BK85	1.23	BK24	BK30	1.33	BK22	BK30
1.00	BK28	BK28	1.06	BK90	BK95	1.14	BK19	BK22	1.23	BK45	BK55	1.33	BK25	BK34
1.00	BK30	BK30	1.06	BK32	BK34	1.14	BK26	BK30	1.24	BK57	BK70	1.33	BK28	BK40
1.00	BK32	BK32	1.06	BK52	BK55	1.15	BK57	BK65	1.24	BK19	BK24	1.33	BK34	BK50
1.00	BK34	BK34	1.06	BK85	BK90	1.15	BK50	BK57	1.24	BK65	BK80	1.33	BK47	BK62
1.00	BK36	BK36	1.06	BK30	BK32	1.15	BK105	BK120	1.24	BK77	BK95	1.34	BK105	BK140
1.00	BK40	BK40	1.06	BK80	BK85	1.15	BK70	BK80	1.24	BK27	BK34	1.34	BK90	BK120
1.00	BK45	BK45	1.07	BK28	BK30	1.15	BK40	BK48	1.24	BK85	BK105	1.34	BK75	BK105
1.00	BK46	BK46	1.07	BK47	BK50	1.15	BK48	BK55	1.24	BK105	BK130	1.34	BK30	BK45
1.00	BK47	BK47	1.07	BK75	BK80	1.15	BK100	BK115	1.25	BK22	BK28	1.34	BK60	BK80
1.00	BK48	BK48	1.07	BK45	BK48	1.15	BK24	BK28	1.25	BK30	BK40	1.35	BK45	BK60
1.00	BK50	BK50	1.07	BK26	BK28	1.15	BK67	BK77	1.25	BK34	BK47	1.35	BK32	BK48
1.00	BK52	BK52	1.07	BK72	BK77	1.16	BK36	BK46	1.25	BK40	BK52	1.35	BK67	BK90
1.00	BK55	BK55	1.07	BK70	BK75	1.16	BK65	BK75	1.25	BK46	BK57	1.35	BK50	BK67
1.00	BK57	BK57	1.07	BK25	BK27	1.16	BK23	BK27	1.25	BK50	BK62	1.36	BK26	BK36
1.00	BK60	BK60	1.07	BK40	BK45	1.16	BK52	BK60	1.25	BK62	BK77	1.36	BK23	BK32
1.00	BK62	BK62	1.08	BK24	BK26	1.16	BK95	BK110	1.26	BK80	BK100	1.36	BK52	BK70
1.00	BK65	BK65	1.08	BK67	BK72	1.16	BK45	BK52	1.26	BK72	BK90	1.36	BK85	BK115
1.00	BK67	BK67	1.08	BK65	BK70	1.17	BK22	BK26	1.26	BK25	BK32	1.36	BK46	BK62
1.00	BK70	BK70	1.08	BK23	BK25	1.17	BK62	BK72	1.26	BK60	BK75	1.36	BK57	BK77
1.00	BK72	BK72	1.08	BK22	BK24	1.17	BK90	BK105	1.26	BK52	BK65	1.37	BK70	BK95
1.00	BK75	BK75	1.08	BK62	BK67	1.17	BK27	BK32	1.26	BK48	BK60	1.37	BK48	BK65
1.00	BK77	BK77	1.09	BK60	BK65	1.17	BK60	BK70	1.26	BK36	BK50	1.37	BK77	BK105
1.00	BK80	BK80	1.09	BK48	BK52	1.17	BK77	BK90	1.26	BK32	BK45	1.37	BK30	BK46
1.00	BK85	BK85	1.09	BK46	BK50	1.18	BK32	BK40	1.27	BK28	BK36	1.37	BK40	BK57
1.00	BK90	BK90	1.09	BK57	BK62	1.18	BK47	BK55	1.27	BK95	BK120	1.38	BK95	BK130
1.00	BK95	BK95	1.09	BK110	BK120	1.18	BK85	BK100	1.27	BK57	BK72	1.38	BK55	BK75
1.00	BK100	BK100	1.09	BK55	BK60	1.18	BK57	BK67	1.27	BK75	BK95	1.38	BK27	BK40
1.00	BK105	BK105	1.10	BK105	BK115	1.18	BK36	BK47	1.28	BK67	BK85	1.38	BK19	BK27
1.00	BK110	BK110	1.10	BK40	BK46	1.18	BK25	BK30	1.28	BK34	BK48	1.38	BK62	BK85
1.00	BK115	BK115	1.10	BK52	BK57	1.18	BK110	BK130	1.28	BK110	BK140	1.38	BK24	BK34
1.02	BK47	BK48	1.10	BK100	BK110	1.19	BK72	BK85	1.28	BK45	BK57	1.38	BK80	BK110
1.02	BK46	BK47	1.10	BK70	BK77	1.19	BK30	BK36	1.28	BK23	BK30	1.39	BK34	BK52
1.02	BK45	BK46	1.10	BK27	BK30	1.19	BK55	BK65	1.28	BK55	BK70	1.39	BK36	BK55
1.03	BK75	BK77	1.10	BK50	BK55	1.19	BK19	BK23	1.28	BK90	BK115	1.39	BK45	BK62
1.03	BK70	BK72	1.11	BK77	BK85	1.19	BK65	BK77	1.28	BK19	BK25	1.40	BK65	BK90
1.03	BK65	BK67	1.11	BK95	BK105	1.19	BK80	BK95	1.28	BK26	BK34	1.40	BK115	BK160
1.03	BK27	BK28	1.11	BK25	BK28	1.19	BK34	BK45	1.29	BK47	BK60	1.40	BK47	BK65
1.03	BK60	BK62	1.11	BK34	BK40	1.20	BK48	BK57	1.29	BK60	BK77	1.40	BK52	BK72
1.04	BK26	BK27	1.11	BK47	BK52	1.20	BK23	BK28	1.29	BK32	BK46	1.40	BK72	BK100
1.04	BK25	BK26	1.11	BK65	BK72	1.20	BK28	BK34	1.29	BK70	BK90	1.40	BK30	BK47
1.04	BK55	BK57	1.11	BK90	BK100	1.20	BK40	BK50	1.30	BK52	BK67	1.41	BK25	BK36
1.04	BK24	BK25	1.11	BK72	BK80	1.20	BK52	BK62	1.30	BK62	BK80	1.41	BK100	BK140
1.04	BK23	BK24	1.11	BK24	BK27	1.20	BK67	BK80	1.30	BK85	BK110	1.41	BK32	BK50
1.04	BK77	BK80	1.12	BK45	BK50	1.20	BK100	BK120	1.30	BK48	BK62	1.41	BK75	BK105
1.04	BK22	BK23	1.12	BK32	BK36	1.20	BK46	BK55	1.31	BK100	BK130	1.41	BK48	BK67
1.04	BK50	BK52	1.12	BK23	BK26	1.21	BK75	BK90	1.31	BK77	BK100	1.41	BK55	BK77
1.04	BK72	BK75	1.12	BK85	BK95	1.21	BK60	BK72	1.31	BK24	BK32	1.41	BK22	BK32
1.04	BK48	BK50	1.12	BK60	BK67	1.21	BK22	BK27	1.31	BK27	BK36	1.42	BK50	BK70
1.04	BK115	BK120	1.12	BK67	BK75	1.21	BK50	BK60	1.31	BK50	BK65	1.42	BK57	BK80
1.05	BK46	BK48	1.12	BK22	BK25	1.21	BK36	BK48	1.31	BK36	BK52	1.42	BK85	BK120
1.05	BK67	BK70	1.12	BK30	BK34	1.21	BK26	BK32	1.32	BK65	BK85	1.43	BK19	BK28
1.05	BK110	BK115	1.12	BK40	BK47	1.21	BK95	BK115	1.32	BK46	BK60	1.43	BK26	BK40
1.05	BK45	BK47	1.13	BK80	BK90	1.22	BK62	BK75	1.32	BK55	BK72	1.43	BK67	BK95

Drive Ratios Using 5L, BP & BX Belts In BK Sheaves

Ratio	DR	DN	Ratio	DR	DN	Ratio	DR	DN	Ratio	DR	DN	Ratio	DR	DN
1.43	BK60	BK85	1.55	BK47	BK72	1.69	BK57	BK95	1.84	BK36	BK72	2.03	BK60	BK120
1.43	BK46	BK65	1.55	BK65	BK100	1.69	BK48	BK80	1.84	BK24	BK50	2.03	BK24	BK55
1.43	BK28	BK45	1.56	BK32	BK55	1.70	BK45	BK75	1.84	BK47	BK85	2.04	BK55	BK110
1.44	BK30	BK48	1.56	BK52	BK80	1.70	BK40	BK70	1.85	BK55	BK100	2.04	BK50	BK100
1.44	BK23	BK34	1.56	BK30	BK52	1.70	BK95	BK160	1.85	BK25	BK52	2.04	BK19	BK45
1.44	BK77	BK110	1.56	BK50	BK77	1.70	BK25	BK48	1.85	BK32	BK65	2.04	BK45	BK90
1.44	BK70	BK100	1.56	BK55	BK85	1.70	BK46	BK77	1.86	BK52	BK95	2.05	BK36	BK80
1.44	BK47	BK67	1.57	BK90	BK140	1.70	BK32	BK60	1.86	BK60	BK110	2.05	BK57	BK115
1.45	BK36	BK57	1.57	BK26	BK46	1.71	BK77	BK130	1.87	BK22	BK47	2.05	BK32	BK72
1.45	BK80	BK115	1.57	BK77	BK120	1.71	BK36	BK67	1.87	BK57	BK105	2.06	BK52	BK105
1.45	BK40	BK60	1.57	BK40	BK65	1.71	BK19	BK34	1.87	BK65	BK120	2.06	BK47	BK95
1.45	BK90	BK130	1.58	BK36	BK62	1.71	BK26	BK50	1.87	BK30	BK62	2.06	BK27	BK62
1.46	BK50	BK72	1.58	BK45	BK70	1.71	BK65	BK110	1.87	BK40	BK77	2.07	BK26	BK60
1.46	BK52	BK75	1.58	BK22	BK36	1.72	BK62	BK105	1.88	BK70	BK130	2.07	BK40	BK85
1.46	BK24	BK36	1.58	BK67	BK105	1.72	BK30	BK57	1.88	BK62	BK115	2.08	BK22	BK52
1.46	BK110	BK160	1.58	BK27	BK48	1.72	BK23	BK45	1.88	BK46	BK85	2.08	BK34	BK77
1.46	BK45	BK65	1.59	BK48	BK75	1.72	BK27	BK52	1.89	BK34	BK70	2.09	BK19	BK46
1.46	BK28	BK46	1.59	BK70	BK110	1.73	BK24	BK47	1.89	BK26	BK55	2.10	BK28	BK65
1.47	BK62	BK90	1.59	BK46	BK72	1.73	BK50	BK85	1.89	BK75	BK140	2.10	BK77	BK160
1.47	BK32	BK52	1.59	BK25	BK45	1.73	BK47	BK80	1.89	BK27	BK57	2.11	BK24	BK57
1.47	BK34	BK55	1.60	BK23	BK40	1.73	BK70	BK120	1.90	BK19	BK40	2.11	BK46	BK95
1.47	BK55	BK80	1.60	BK28	BK50	1.74	BK67	BK115	1.90	BK85	BK160	2.11	BK23	BK55
1.47	BK72	BK105	1.60	BK57	BK90	1.74	BK110	BK190	1.91	BK32	BK67	2.12	BK30	BK70
1.48	BK65	BK95	1.60	BK60	BK95	1.74	BK45	BK77	1.91	BK48	BK90	2.12	BK67	BK140
1.48	BK46	BK67	1.60	BK26	BK47	1.75	BK34	BK65	1.91	BK22	BK48	2.13	BK48	BK100
1.48	BK48	BK70	1.61	BK34	BK60	1.75	BK40	BK72	1.92	BK23	BK50	2.13	BK55	BK115
1.48	BK75	BK110	1.61	BK100	BK160	1.75	BK75	BK130	1.92	BK100	BK190	2.13	BK62	BK130
1.48	BK25	BK40	1.61	BK72	BK115	1.75	BK55	BK95	1.92	BK36	BK75	2.13	BK90	BK190
1.48	BK27	BK45	1.62	BK19	BK32	1.76	BK23	BK46	1.92	BK24	BK52	2.14	BK19	BK47
1.48	BK95	BK140	1.62	BK32	BK57	1.76	BK52	BK90	1.93	BK45	BK85	2.14	BK26	BK62
1.50	BK22	BK34	1.62	BK75	BK120	1.76	BK32	BK62	1.93	BK28	BK60	2.14	BK25	BK60
1.50	BK28	BK47	1.62	BK47	BK75	1.76	BK28	BK55	1.93	BK50	BK95	2.14	BK32	BK75
1.50	BK30	BK50	1.62	BK40	BK67	1.77	BK24	BK48	1.94	BK34	BK72	2.14	BK50	BK105
1.50	BK40	BK62	1.62	BK50	BK80	1.77	BK80	BK140	1.94	BK55	BK105	2.14	BK57	BK120
1.50	BK52	BK77	1.63	BK45	BK72	1.77	BK46	BK80	1.95	BK60	BK115	2.16	BK52	BK110
1.51	BK77	BK115	1.63	BK25	BK46	1.77	BK25	BK50	1.95	BK40	BK80	2.16	BK45	BK95
1.51	BK67	BK100	1.63	BK48	BK77	1.77	BK60	BK105	1.95	BK47	BK90	2.16	BK28	BK67
1.51	BK57	BK85	1.63	BK62	BK100	1.78	BK57	BK100	1.96	BK52	BK100	2.16	BK75	BK160
1.51	BK47	BK70	1.63	BK65	BK105	1.78	BK26	BK52	1.96	BK25	BK55	2.16	BK34	BK80
1.51	BK45	BK67	1.64	BK26	BK48	1.79	BK36	BK70	1.96	BK26	BK57	2.17	BK27	BK65
1.51	BK80	BK120	1.64	BK80	BK130	1.79	BK22	BK45	1.96	BK57	BK110	2.17	BK47	BK100
1.51	BK70	BK105	1.65	BK24	BK45	1.79	BK65	BK115	1.96	BK62	BK120	2.18	BK36	BK85
1.51	BK27	BK46	1.65	BK27	BK50	1.79	BK90	BK160	1.96	BK30	BK65	2.18	BK30	BK72
1.52	BK60	BK90	1.65	BK30	BK55	1.80	BK23	BK47	1.97	BK67	BK130	2.18	BK19	BK48
1.52	BK23	BK36	1.66	BK36	BK65	1.80	BK62	BK110	1.97	BK72	BK140	2.19	BK65	BK140
1.52	BK50	BK75	1.66	BK46	BK75	1.80	BK48	BK85	1.97	BK36	BK77	2.19	BK23	BK57
1.52	BK48	BK72	1.66	BK52	BK85	1.80	BK34	BK67	1.99	BK22	BK50	2.20	BK40	BK90
1.52	BK19	BK30	1.66	BK55	BK90	1.80	BK19	BK36	1.99	BK23	BK52	2.20	BK32	BK77
1.52	BK36	BK60	1.66	BK67	BK110	1.81	BK30	BK60	2.00	BK27	BK60	2.20	BK22	BK55
1.53	BK34	BK57	1.66	BK70	BK115	1.81	BK45	BK80	2.00	BK28	BK62	2.20	BK60	BK130
1.53	BK28	BK48	1.66	BK85	BK140	1.81	BK67	BK120	2.00	BK32	BK70	2.22	BK25	BK62
1.53	BK26	BK45	1.66	BK115	BK190	1.82	BK40	BK75	2.00	BK46	BK90	2.22	BK55	BK120
1.53	BK105	BK160	1.66	BK22	BK40	1.82	BK27	BK55	2.02	BK48	BK95	2.22	BK46	BK100
1.54	BK24	BK40	1.66	BK25	BK47	1.82	BK105	BK190	2.02	BK95	BK190	2.22	BK24	BK60
1.54	BK85	BK130	1.66	BK28	BK52	1.83	BK72	BK130	2.02	BK80	BK160	2.24	BK48	BK105
1.54	BK72	BK110	1.66	BK34	BK62	1.83	BK22	BK46	2.02	BK34	BK75	2.24	BK27	BK67
1.54	BK46	BK70	1.66	BK47	BK77	1.83	BK28	BK57	2.03	BK30	BK67	2.24	BK26	BK65
1.55	BK75	BK115	1.68	BK72	BK120	1.83	BK50	BK90	2.03	BK70	BK140	2.25	BK50	BK110
1.55	BK62	BK95	1.69	BK60	BK100	1.84	BK23	BK48	2.03	BK65	BK130	2.25	BK72	BK160
1.55	BK27	BK47	1.69	BK24	BK46	1.84	BK77	BK140	2.03	BK25	BK57	2.26	BK52	BK115

Drive Ratios Using 5L, BP & BX Belts In BK Sheaves

Ratio	DR	DN	Ratio	DR	DN	Ratio	DR	DN	Ratio	DR	DN	Ratio	DR	DN
2.26	BK28	BK70	2.51	BK23	BK65	2.88	BK24	BK77	3.43	BK48	BK160	4.30	BK30	BK140
2.26	BK85	BK190	2.51	BK19	BK55	2.88	BK25	BK80	3.43	BK25	BK95	4.30	BK23	BK110
2.28	BK45	BK100	2.56	BK52	BK130	2.89	BK67	BK190	3.44	BK40	BK140	4.33	BK24	BK115
2.28	BK30	BK75	2.56	BK48	BK120	2.90	BK30	BK95	3.45	BK22	BK85	4.35	BK25	BK120
2.28	BK19	BK50	2.56	BK46	BK115	2.90	BK46	BK130	3.46	BK19	BK75	4.36	BK45	BK190
2.28	BK22	BK57	2.57	BK40	BK105	2.91	BK22	BK72	3.46	BK32	BK120	4.38	BK34	BK160
2.29	BK47	BK105	2.57	BK75	BK190	2.91	BK23	BK75	3.49	BK26	BK100	4.40	BK27	BK130
2.29	BK32	BK80	2.57	BK36	BK100	2.92	BK28	BK90	3.50	BK47	BK160	4.41	BK19	BK95
2.30	BK62	BK140	2.58	BK34	BK95	2.94	BK40	BK120	3.51	BK23	BK90	4.48	BK22	BK110
2.30	BK34	BK85	2.58	BK27	BK77	2.96	BK26	BK85	3.52	BK30	BK115	4.50	BK23	BK115
2.30	BK24	BK62	2.58	BK32	BK90	2.97	BK36	BK115	3.54	BK27	BK105	4.52	BK24	BK120
2.31	BK36	BK90	2.58	BK25	BK72	2.97	BK45	BK130	3.54	BK55	BK190	4.55	BK26	BK130
2.31	BK23	BK60	2.59	BK30	BK85	2.98	BK55	BK160	3.55	BK34	BK130	4.58	BK28	BK140
2.32	BK26	BK67	2.59	BK23	BK67	2.98	BK65	BK190	3.56	BK19	BK77	4.63	BK32	BK160
2.32	BK40	BK95	2.59	BK28	BK80	2.99	BK19	BK65	3.56	BK24	BK95	4.64	BK19	BK100
2.32	BK70	BK160	2.60	BK26	BK75	2.99	BK23	BK77	3.58	BK46	BK160	4.69	BK40	BK190
2.32	BK57	BK130	2.60	BK55	BK140	2.99	BK24	BK80	3.59	BK28	BK110	4.69	BK22	BK115
2.33	BK25	BK65	2.61	BK24	BK70	2.99	BK34	BK110	3.62	BK25	BK100	4.70	BK23	BK120
2.33	BK28	BK72	2.61	BK19	BK57	2.99	BK48	BK140	3.62	BK36	BK140	4.72	BK25	BK130
2.34	BK46	BK105	2.62	BK22	BK65	3.02	BK32	BK105	3.65	BK22	BK90	4.74	BK27	BK140
2.34	BK30	BK77	2.62	BK47	BK120	3.03	BK27	BK90	3.67	BK26	BK105	4.88	BK19	BK105
2.34	BK27	BK70	2.62	BK45	BK115	3.03	BK22	BK75	3.67	BK45	BK160	4.90	BK22	BK120
2.34	BK48	BK110	2.63	BK62	BK160	3.05	BK30	BK100	3.68	BK30	BK120	4.90	BK24	BK130
2.35	BK50	BK115	2.66	BK50	BK130	3.06	BK47	BK140	3.70	BK19	BK80	4.91	BK26	BK140
2.36	BK52	BK120	2.67	BK26	BK77	3.06	BK25	BK85	3.71	BK23	BK95	4.92	BK30	BK160
2.37	BK19	BK52	2.68	BK46	BK120	3.08	BK19	BK67	3.71	BK27	BK110	4.93	BK36	BK190
2.38	BK60	BK140	2.68	BK27	BK80	3.09	BK28	BK95	3.75	BK52	BK190	5.09	BK25	BK140
2.39	BK45	BK105	2.68	BK72	BK190	3.10	BK36	BK120	3.75	BK32	BK130	5.10	BK23	BK130
2.39	BK23	BK62	2.68	BK24	BK72	3.11	BK23	BK80	3.75	BK28	BK115	5.12	BK19	BK110
2.40	BK47	BK110	2.69	BK40	BK110	3.11	BK22	BK77	3.76	BK24	BK100	5.21	BK34	BK190
2.40	BK25	BK67	2.70	BK25	BK75	3.13	BK62	BK190	3.80	BK25	BK105	5.25	BK28	BK160
2.41	BK27	BK72	2.70	BK22	BK67	3.13	BK46	BK140	3.82	BK34	BK140	5.29	BK24	BK140
2.41	BK80	BK190	2.70	BK36	BK105	3.13	BK34	BK115	3.84	BK26	BK110	5.31	BK22	BK130
2.41	BK22	BK60	2.71	BK23	BK70	3.13	BK26	BK90	3.86	BK22	BK95	5.35	BK19	BK115
2.41	BK55	BK130	2.72	BK34	BK100	3.15	BK52	BK160	3.88	BK27	BK115	5.43	BK27	BK160
2.42	BK24	BK65	2.72	BK60	BK160	3.17	BK32	BK110	3.90	BK23	BK100	5.50	BK23	BK140
2.42	BK26	BK70	2.73	BK32	BK95	3.18	BK24	BK85	3.91	BK50	BK190	5.51	BK32	BK190
2.43	BK28	BK75	2.74	BK45	BK120	3.19	BK40	BK130	3.92	BK28	BK120	5.59	BK19	BK120
2.43	BK67	BK160	2.74	BK30	BK90	3.20	BK27	BK95	3.93	BK19	BK85	5.62	BK26	BK160
2.43	BK30	BK80	2.75	BK19	BK60	3.20	BK45	BK140	3.94	BK40	BK160	5.72	BK22	BK140
2.44	BK32	BK85	2.76	BK52	BK140	3.21	BK30	BK105	3.95	BK24	BK105	5.83	BK25	BK160
2.44	BK34	BK90	2.76	BK28	BK85	3.22	BK19	BK70	3.99	BK25	BK110	5.86	BK30	BK190
2.44	BK36	BK95	2.76	BK70	BK190	3.24	BK60	BK190	3.99	BK30	BK130	6.05	BK24	BK160
2.45	BK40	BK100	2.77	BK25	BK77	3.24	BK22	BK80	4.02	BK26	BK115	6.06	BK19	BK130
2.45	BK46	BK110	2.78	BK26	BK80	3.25	BK25	BK90	4.05	BK32	BK140	6.24	BK28	BK190
2.45	BK48	BK115	2.78	BK48	BK130	3.26	BK28	BK100	4.06	BK27	BK120	6.29	BK23	BK160
2.45	BK50	BK120	2.79	BK23	BK72	3.27	BK34	BK120	4.07	BK22	BK100	6.46	BK27	BK190
2.49	BK22	BK62	2.80	BK24	BK75	3.29	BK50	BK160	4.08	BK48	BK190	6.54	BK19	BK140
2.49	BK24	BK67	2.82	BK40	BK115	3.31	BK23	BK85	4.10	BK23	BK105	6.55	BK22	BK160
2.49	BK26	BK72	2.82	BK22	BK70	3.31	BK26	BK95	4.14	BK24	BK110	6.69	BK26	BK190
2.49	BK28	BK77	2.84	BK36	BK110	3.31	BK32	BK115	4.15	BK36	BK160	6.93	BK25	BK190
2.50	BK77	BK190	2.84	BK47	BK130	3.32	BK19	BK72	4.17	BK47	BK190	7.20	BK24	BK190
2.50	BK65	BK160	2.85	BK19	BK62	3.36	BK36	BK130	4.17	BK25	BK115	7.48	BK19	BK160
2.51	BK57	BK140	2.85	BK27	BK85	3.37	BK30	BK110	4.17	BK19	BK90	7.49	BK23	BK190
2.51	BK47	BK115	2.85	BK34	BK105	3.37	BK27	BK100	4.20	BK26	BK120	7.80	BK22	BK190
2.51	BK45	BK110	2.87	BK57	BK160	3.37	BK24	BK90	4.25	BK28	BK130	8.90	BK19	BK190
2.51	BK27	BK75	2.87	BK50	BK140	3.41	BK57	BK190	4.26	BK46	BK190			
2.51	BK25	BK70	2.88	BK32	BK100	3.42	BK28	BK105	4.27	BK22	BK105			

HP Ratings - 3L, 4L, 5L Belts

	1750		3500	
	3L	4L	3L	4L
AK15	-	-	-	-
AK16	-	-	-	-
AK17	-	0.01	-	-
AK18	-	0.07	-	-
AK19	-	0.14	-	-
AK20	0.18	0.20	0.26	0.07
AK21	0.21	0.26	0.31	0.16
AK22	0.24	0.32	0.36	0.25
AK23	0.27	0.39	0.42	0.33
AK24	0.30	0.45	0.47	0.41
AK25	0.33	0.50	0.51	0.49
AK26	0.36	0.56	0.56	0.57
AK27	0.38	0.62	0.61	0.63
AK28	0.41	0.68	0.66	0.70
AK30	0.47	0.79	0.74	0.81
AK32	0.53	0.90	0.83	0.91
AK34	0.58	1.01	0.91	0.99
AK35	0.61	1.06	0.94	1.02
AK39	0.66	1.16	1.02	1.06
AK41	0.72	1.26	1.08	1.09
AK44	0.79	1.40	1.17	1.07
AK46	0.84	1.49	1.22	1.03
AK49		1.62		0.93
AK51		1.70		0.82
AK54		1.81		0.60
AK56		1.88		0.42
AK59		1.98		0.08
AK61		2.04		
AK64		2.12		
AK66		2.17		
AK69		2.23		
AK71		2.26		
AK74		2.30		

Consult Factory

	1750		3500	
	4L	5L	4L	5L
BK19	-	-	-	-
BK22	0.07	-	-	-
BK23	0.14	-	-	-
BK24	0.20	0.03	0.07	-
BK25	0.26	0.14	0.16	-
BK26	0.32	0.24	0.25	-
BK27	0.39	0.34	0.33	-
BK28	0.45	0.44	0.41	0.14
BK30	0.56	0.64	0.57	0.45
BK32	0.68	0.84	0.70	0.74
BK34	0.79	1.04	0.81	1.02
BK36	0.90	1.23	0.91	1.28
BK40	1.01	1.42	0.99	1.53
BK45	1.16	1.70	1.06	1.86
BK46	1.21	1.79	1.08	1.97
BK47	1.26	1.88	1.09	2.07
BK48	1.31	1.97	1.09	2.16
BK50	1.40	2.15	1.07	2.34
BK52	1.49	2.32	1.03	2.49
BK55	1.62	2.58	0.93	2.69
BK57	1.70	2.75	0.82	2.79
BK60	1.81	2.99	0.60	2.91
BK62	1.88	3.15	0.42	2.96
BK65	1.98	3.38	0.08	2.98
BK67	2.04	3.53		2.97
BK70	2.12	3.75		2.91
BK72	2.17	3.89		2.83
BK75	2.23	4.10		2.66
BK77	2.26	4.23		2.52
BK80	2.30	4.42		2.24
BK85		4.71		1.63
BK90		4.98		0.82
BK95		5.22		
BK100		5.44		

HP Ratings - "A & B" Belts

	1750		3500	
	AP	AX	AP	AX
AK15	-	-	-	-
AK16	-	-	-	-
AK17	-	-	-	-
AK18	-	-	-	-
AK19	-	0.09	-	-
AK20	-	0.29	-	-
AK21	0.06	0.48	-	0.29
AK22	0.26	0.68	-	0.64
AK23	0.45	0.87	0.11	0.99
AK24	0.64	1.06	0.44	1.33
AK25	0.83	1.25	0.78	1.67
AK26	1.02	1.44	1.11	2.01
AK27	1.21	1.63	1.44	2.35
AK28	1.39	1.82	1.76	2.68
AK30	1.77	2.19	2.40	3.33
AK32	2.13	2.57	3.02	3.98
AK34	2.50	2.93	3.63	4.61
AK35	2.68	3.11	3.93	4.92
AK39	3.04	3.48	4.51	5.53
AK41	3.39	3.84	5.08	6.13
AK44	3.92	4.37	5.91	7.00
AK46	4.26	4.72	6.44	7.57
AK49	4.78	5.24	7.20	8.39
AK51	5.11	5.58	7.68	8.92
AK54	5.61	6.09	8.38	9.69
AK56	5.94	6.43	8.82	10.18
AK59	6.43	6.93	9.44	10.89
AK61	6.75	7.25	9.83	11.35
AK64	7.22	7.74	10.38	12.00
AK66	7.53	8.06	10.71	12.41
AK69	7.99	8.54	-	-
AK71	8.29	8.85	-	-
AK74	8.73	9.31	-	-

	1750				3500			
	AP	AX	BP	BX	AP	AX	BP	BX
BK19	-	-	-	-	-	-	-	-
BK22	-	-	-	-	-	-	-	-
BK23	-	0.09	-	-	-	-	-	-
BK24	-	0.29	0.16	-	-	-	-	-
BK25	0.06	0.48	-	0.48	-	0.29	-	-
BK26	0.26	0.68	-	0.78	-	0.64	-	0.20
BK27	0.45	0.87	-	1.09	0.11	0.99	-	0.75
BK28	0.64	1.06	-	1.40	0.44	1.33	-	1.29
BK30	1.02	1.44	0.37	2.01	1.11	2.01	-	2.36
BK32	1.39	1.82	0.95	2.61	1.76	2.68	-	3.41
BK34	1.77	2.19	1.53	3.21	2.40	3.33	0.73	4.44
BK36	2.13	2.57	2.10	3.81	3.02	3.98	1.65	5.45
BK40	2.50	2.93	2.66	4.40	3.63	4.61	2.55	6.44
BK45	3.04	3.48	3.50	5.27	4.51	5.53	3.86	7.89
BK46	3.21	3.66	3.78	5.56	4.80	5.83	4.28	8.36
BK47	3.39	3.84	4.05	5.85	5.08	6.13	4.69	8.82
BK48	3.57	4.01	4.32	6.14	5.36	6.42	5.10	9.28
BK50	3.92	4.37	4.87	6.71	5.91	7.00	5.89	10.18
BK52	4.26	4.72	5.40	7.28	6.44	7.57	6.65	11.06
BK55	4.78	5.24	6.20	8.12	7.20	8.39	7.74	12.33
BK57	5.11	5.58	6.72	8.67	7.68	8.92	8.43	13.15
BK60	5.61	6.09	7.50	9.49	8.38	9.69	9.40	14.32
BK62	5.94	6.43	8.00	10.04	8.82	10.18	10.00	15.07
BK65	6.43	6.93	8.76	10.84	9.44	10.89	10.85	16.15
BK67	6.75	7.25	9.25	11.37	9.83	11.35	11.37	16.83
BK70	7.22	7.74	9.98	12.16	10.38	12.00	12.08	17.80
BK72	7.53	8.06	10.46	12.68	10.71	12.41	12.51	18.41
BK75	7.99	8.54	11.17	13.45	-	-	-	-
BK77	8.29	8.85	11.63	13.95	-	-	-	-
BK80	8.73	9.31	12.31	14.70	-	-	-	-
BK85			13.42	15.92	-	-	-	-
BK90			14.48	17.11	-	-	-	-
BK95			15.51	18.26	-	-	-	-
BK100			16.48	19.38	-	-	-	-

Consult Factory

Light-Duty Drive

Design Charts

3L, 4L, 5L BELT SERVICE FACTORS

Type of DriveN Unit	Speed Ratio	
	Less Than 1.5	1.5 and Over
Fans and Blowers	1.0	0.9
Domestic Laundry Machines	1.1	1.0
Centrifugal Pumps	1.1	1.0
Generators	1.2	1.1
Rotary Compressors	1.2	1.1
Machine Tools	1.3	1.2
Reciprocating Pumps	1.4	1.3
Reciprocating Compressors	1.4	1.3
Wood Working Machines	1.4	1.3

BELT SECTION SELECTION

Maximum Motor Ratings Single Groove	Use
1/2 hp	3L
1 hp	4L
3	5L
5	A
7.5	B

dual groove = 2 times single groove

NEMA Minimum Motor Sheave Recommendation

Motor Horsepower	MOTOR RPM			
	870	1160	1750	3500
1/2	2.2	-	-	-
3/4	2.4	2.2	-	-
1	2.4	2.4	2.2	-
1-1/2	2.4	2.4	2.4	2.2
2	3.0	2.4	2.4	2.4
3	3.0	3.0	2.4	2.4
5	3.8	3.0	3.0	2.6
7-1/2	4.4	3.8	3.0	3.0
10	4.6	4.4	3.8	3.0
15	5.4	4.6	4.4	3.8
20	6.0	5.4	4.6	4.4
25	6.8	6.0	5.0	4.4
30	6.8	6.8	5.4	-
40	8.2	6.8	6.0	-
50	9.0	8.2	6.8	-
60	10.0	9.0	7.4	-
75	10.5	10.0	9.0	-
100	12.5	11.0	10.0	-
125	-	12.5	11.5	-
150	-	-	-	-
200	-	-	-	-
250	-	-	-	-
300	-	-	-	-

Approximate Belt Length Calculation

$$BL = 1.571 (D1 + D2) + 2 CD$$

D1 & D2 = Sheave Diameters CD = Center Distance

Light-Duty Drives Using A & B Belting

Service Factor

SERVICE FACTORS

DRIVEN MACHINE See Note 1	DRIVERS					
	AC Normal Torque Electric Motor (NEMA Design A-B) See Note 2			AC High Torque Electric Motor (NEMA Design C-D) See Note 3		
	Intermittent Service See Note 4	Normal Service See Note 5	Continuous Service See Note 6	Intermittent Service See Note 4	Normal Service See Note 5	Continuous Service See Note 6
Agitators for Liquids						
Blowers and Exhausters						
Centrifugal Pumps and Compressors	1.0	1.1	1.2	1.1	1.2	1.3
Conveyors (Light Duty)						
Fans (up to 10 H.P.)						
Belt Conveyors for Sand, Grain, etc.						
Fans (over 10 H.P.)						
Generators						
Laundry Machinery						
Line Shafts						
Machine Tools	1.1	1.2	1.3	1.2	1.3	1.4
Mixers (Dough)						
Positive Displacement Rotary Pumps						
Printing Machinery						
Punches-Presses-Shears See Note 1						
Revolving and Vibrating Screens						
Blowers (Positive Displacement)						
Brick Machinery						
Compressors (Piston) See Note 1						
Conveyors (Drag-Pan-Screw)						
Elevators (Bucket)						
Exciters	1.2	1.3	1.4	1.4	1.5	1.6
Hammer Mills						
Paper Mill Beaters						
Pulverizers						
Pumps (Piston)						
Saw Mill and Woodworking Machinery						
Textile Machinery						
Crushers (Gyratory-Jaw-Roll) See Note 1						
Mills (Ball-Rod-Tube) See Note 1	1.3	1.4	1.5	1.5	1.6	1.6
Hoists See Note 1						
Rubber Calenders-Extruders-Mills See Note 1						

Note 1 The Driven Machines listed above are representative samples only. When one of the sheaves of the drive is used as a flywheel to reduce speed fluctuations and equalize the energy exerted at the shaft or for applications involving impact or jam loads specially constructed sheaves may be required. Consult the manufacturer.

Note 2 Included under this heading are the following electric motors: Synchronous and Squirrel Cage AC Normal Torque, AC Split Phase, DC Shunt Wound and Internal Combustion Engines.

Note 3 Included under this heading are the following electric motors: AC High Torque, AC Hi-Slip, AC Repulsion, Induction, AC Single Phase Series Wound, AC Slip Ring and DC Compound Wound.

Note 4 Intermittent Service refers to 3–5 hours of daily or seasonal operation.

Note 5 Normal Service indicates 8–10 hours of daily operation.

Note 6 Continuous Service refers to 16–24 hours of daily operation.

Light-Duty Drives A & B

Correction Factors

SPEED ADD-ON CORRECTION

AP & AX Belts Motor RPM	RATIOS								
	1.00-1.01	1.02-1.05	1.06-1.09	1.10-1.14	1.15-1.19	1.20-1.29	1.30-1.49	1.50-1.99	2.00 & Over
1750	.00	.03	.07	.10	.13	.16	.20	.24	.27
3600	.00	.05	.13	.19	.26	.31	.39	.47	.54

BP & BX Belts Motor RPM	RATIOS								
	1.00-1.01	1.02-1.05	1.06-1.09	1.10-1.14	1.15-1.19	1.20-1.29	1.30-1.49	1.50-1.99	2.00 & Over
1750	.00	.06	.17	.25	.34	.41	.51	.62	.71
3600	.00	.12	.33	.50	.67	.81	1.01	1.24	1.41

ARC OF CONTACT CORRECTION FACTOR

D - d C	Arc Contact Degree	Factor AC	D - d C	Arc Contact Degree	Factor AC	D - d C	Arc Contact Degree	Factor AC	D - d C	Arc Contact Degree	Factor AC
0.000	180	1.000	0.375	158	0.947	0.750	136	0.879	1.125	112	0.789
0.025	179	0.997	0.400	157	0.943	0.775	134	0.874	1.500	110	0.782
0.050	177	0.994	0.425	155	0.939	0.800	133	0.869	1.750	108	0.774
0.075	176	0.990	0.450	154	0.935	0.825	131	0.864	1.200	106	0.767
0.100	174	0.987	0.475	153	0.930	0.850	130	0.858	1.225	104	0.759
0.125	173	0.983	0.500	151	0.926	0.875	128	0.852	1.250	103	0.751
0.150	171	0.980	0.525	150	0.922	0.900	127	0.847	1.275	101	0.742
0.175	170	0.977	0.550	148	0.917	0.925	125	0.841	0.130	99	0.734
0.200	169	0.973	0.575	147	0.913	0.950	123	0.835	1.325	97	0.725
0.225	167	0.969	0.600	145	0.908	0.975	122	0.829	1.350	95	0.716
0.250	166	0.966	0.625	144	0.904	1.000	120	0.823	1.375	93	0.706
0.275	164	0.962	0.650	142	0.899	1.025	118	0.816	1.400	91	0.697
0.300	163	0.958	0.675	141	0.894	1.050	117	0.810	1.425	89	0.687
0.325	161	0.954	0.700	139	0.889	1.075	115	0.803			
0.350	160	0.951	0.725	137	0.884	1.100	113	0.796			

D = Large Diameter Sheave d = Small Diameter Sheave C = Center Distance

BELT LENGTH CORRECTION FACTOR

Belt Number	Correction Factor LC	Belt Number	Correction Factor LC	Belt Number	Correction Factor LC	Belt Number	Correction Factor LC	Belt Number	Correction Factor LC
A26	.81	A75	1.02	B35	.81	B85	.99	B173	1.15
A31	.84	A80	1.04	B38	.83	B90	1.00	B180	1.16
A35	.87	A85	1.05	B42	.85	B97	1.02	B195	1.18
A38	.88	A90	1.06	B46	.87	B105	1.04	B210	1.19
A42	.90	A96	1.08	B51	.89	B112	1.05	B240	1.22
A46	.92	A105	1.10	B55	.90	B120	1.07	B270	1.25
A51	.94	A112	1.11	B60	.92	B128	1.08	B300	1.27
A55	.96	A120	1.13	B68	.95	B136	1.09		
A60	.98	A128	1.14	B75	.97	B144	1.11		
A68	1.00			B81	.98	B158	1.13		

Light-Duty Drive Selection Using 3L, 4L, 5L Belts

Example: A 1 HP 1750 RPM NEMA B motor driving a fan operating at 1200 RPM, 24 hours a day.
Motor shaft is 7/8" diameter, fan shaft is 1" diameter, center distance is 20".

Procedure	Example
Step #1: Determine Required Drive Ratio. Ratio = Faster RPM / Slower RPM	1750 rpm / 1200 rpm = 1.46 ratio
Step #2: Based on the type of driven machine and the ratio determine the correct service factor from the chart on Page B3—24.	Service factor = 1.0
Step #3: Calculate the Design HP. Design HP = Motor HP x Service Factor	1 HP x 1.0 service factor = 1.0 Design HP
Step #4: Determine Belt Section based on Motor Horsepower. See chart on Page B3—24.	4L belt section
Step #5: Check NEMA chart for minimum sheave diameters. Page B3—24.	1 HP 1750 NEMA minimum diameter = 2.2"
Step #6: Select a drive combination from the ratio chart of the the corresponding belt section. Pages B3—10 to B3—21. In the event of multiple possibilities, drives using larger diameters are usually more economical.	1.46 ratio = AK30 DriveR & AK46 DriveN
Step #7: Using the smaller sheave and the motor RPM compare the HP per belt found on the charts on B3—22 to the Design HP from Step #3. For two groove applications multiply the HP per belt value by two.	HP rating of the AK46 @ 1750 RPM = 1.49 HP
Step #8: Calculate the approximate belt length. BL = 1.571 (D1 + D2) + 2 CD D1 & D2 = the sheave diameters & CD = center distance	BL = 1.571 (4.2 + 6.2) + 2 (20) BL = 51.78 Use a 4L520
Step #9: Specify Product Numbers.	DriveR sheave = AK30 x 7/8 order AK3078 DriveN sheave = AK46 x 1 order AK461 Belt = 4L520

Light-Duty Drive Selection Using AP, AX, BP, BX

Example: A 5 HP 3500 RPM NEMA B motor driving a centrifugal pump operating at 2330 RPM, 24 hours a day.
 Motor shaft is 1-1/8" diameter, fan shaft is 1" diameter, center distance is 25".

Procedure	Example
Step #1: Based on the type of DriveN machine the hours of operation and the DriveR type, select the correct service factor from the chart on page B3–25.	Service factor = 1.2
Step #2: Calculate the Design HP. Design HP = Motor HP x Service Factor	5 HP x 1.2 service factor = 6.0 Design HP
Step #3: Determine Belt Section based on Motor Horsepower. See chart on Page B3–24.	A belt section
Step #4: Determine Required Drive Ratio. Ratio = Faster RPM / Slower RPM	Ratio = 3500 / 2330 = 1.5
Step #5: Check NEMA chart for minimum sheave diameters. Page B3–24.	5 HP 3500 NEMA minimum diameter = 2.4"
Step #6: Select a drive combination from the ratio chart of the corresponding belt section. Pages B3–10 to B3–21. In the event of multiple possibilities, drives using larger diameters are usually more economical.	1.5 ratio = AK61 DriveR & AK91 DriveN
Step #7: Calculate the approximate belt length. BL = 1.571 (D1 + D2) + 2 CD D1 & D2 = the sheave diameters & CD = center distance	BL = 1.571 (5.7 + 8.7) + 2 (25) BL = 72.62 Use an AP71
Step #8: Using the smaller sheave and the motor RPM locate the HP per belt found on the charts on B3–23.	HP rating of the AK61 with an AP belt @ 3500 RPM = 9.83 HP
Step #9: Using the motor RPM and the ratio, find the HP add-on and add this to the HP per belt from Step #8. Page B3–26.	Add-on for A belts and a 1.5 ratio = .47
Step #10: Multiply the HP answer from Step #8 to the AC and LC factor from page B3–26. This is the corrected HP/belt. Compare this answer to the Design HP to determine if corrected HP one or two grooves are needed.	AC = .983 LC for an AP71 belt = 1.00 9.83 x .983 x 1.00 = 9.66 per belt Design HP = 6.0 • one belt will be enough
Step #11: Specify Product Numbers.	DriveR sheave = AK61 x 1-1/8" order AK61118 DriveN sheave = AK 91 x 1 order AK911 Belts = AP71