

Pipe Hooks Manual

Models 231 (A, B & C)
232 (A & B)
233 (A & B)

About Us

We appreciate your business!

Congratulations on your new SAWYER product. We are proud to have you as our customer and will strive to provide you with the best service and reliability in the industry. This product is backed by our extensive warranty and world-wide service network. To locate your nearest distributor or service agency, please contact us at the phone number and address listed on the bottom of each page.

You are in good company!

Sawyer Manufacturing Company is the world leader in the design and manufacture of pipeline and welding equipment and has been since 1948. Sawyer equipment has become a standard in the industry and continues to set the benchmark for quality and durability.

This user operation manual has been made to instruct you for the best use and operation of your Sawyer product. Your satisfaction with our products is our main goal. Please read this entire manual carefully, noting all tips, notes and warnings. Safety always comes first.

Parts Diagram

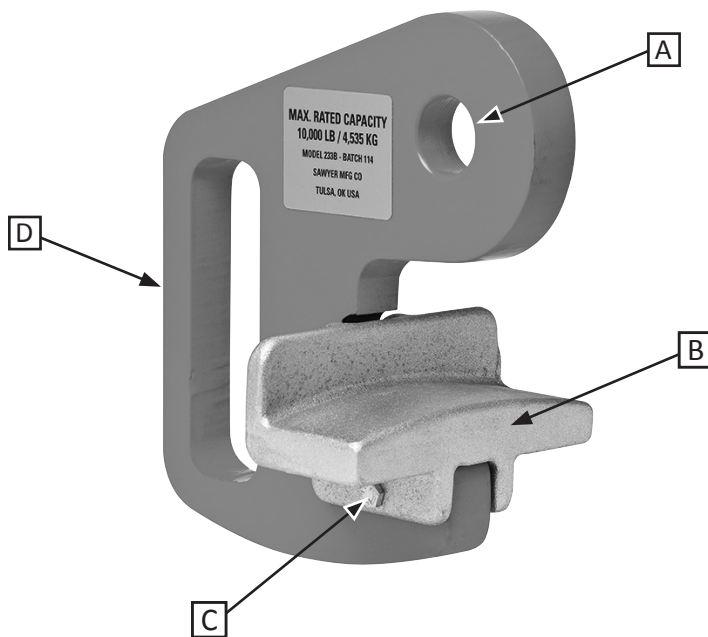



- | | |
|-------------------------------------|----------------------------|
| A. Pipe Hook Lifting Eye | C. 7/16" Bolt |
| B. Aluminum Pipe Hook Insert | D. Pipe Hook Handle |

Record the following information for warranty purposes:

Where purchased: _____

Purchase date: _____

Equipment Serial #: _____

	CAUTION	
<p>CAUTION: Sawyer Manufacturing offers an easy to use line of pipe hooks for the purpose of lifting pipes. Wear all protective gear and stay clear of moving objects. Ensure that the pipe is in place on the pipe hook before lifting. After each use clean and store in a warm, dry area.</p>		

Warranty
<p>All products manufactured by or for Sawyer Manufacturing Company are guaranteed against defects due to faulty workmanship or materials for twelve months from the date of purchase.</p> <p>This guarantee is limited to the repair or replacement of any parts found to be defective, and no other liability—expressed, implied, or contingent—is assumed.</p>

Installation

 **CAUTION** 
Make sure proper load is used on all tools

Tools Needed For Operation*

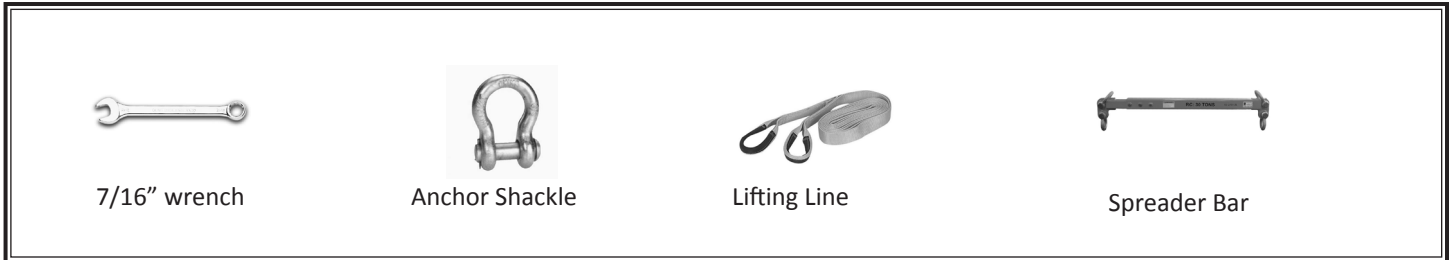

*Not Included

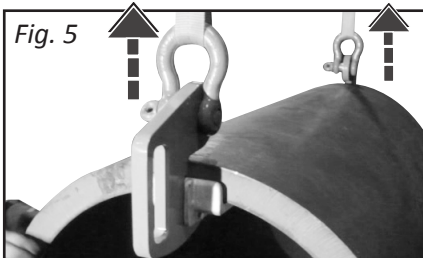
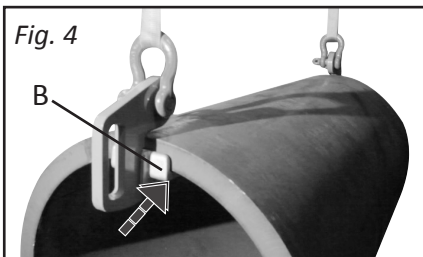
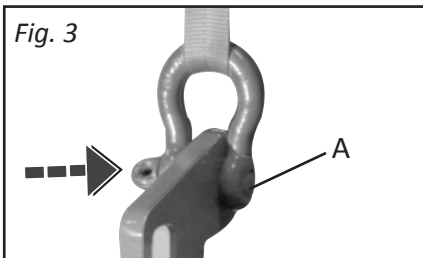
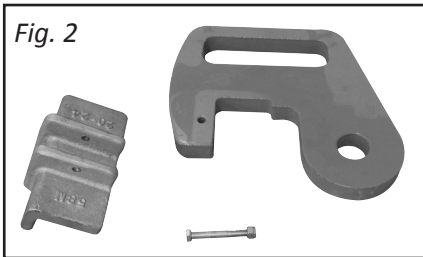
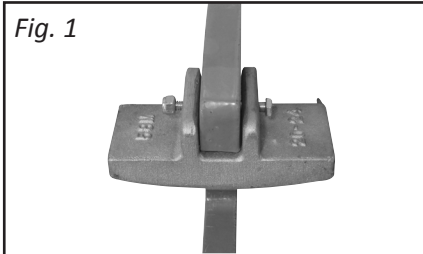



Installation

Note: Pipe Hooks must be used in pairs

Note: To change aluminum inserts (Fig. 1), remove 7/16th bolt and 7/16th nut. Replace with needed size insert. (Fig. 2) Re-insert 7/16th bolt and 7/16th nut.

Operation

1. Place anchor shackle into pipe hook lifting eye. (A) 1 per side. (Fig. 3)
2. Insert hook onto end of pipe - 1 per side, resting on aluminum hook insert. (B, Fig. 4)
3. Lift pipe. (Fig. 5)

 **WARNING** 
WARNING: Make sure hooks are even with each other before lifting pipe. Make sure weight is evenly distributed. Wear protective lifting gear, and stay clear from suspended pipe.